

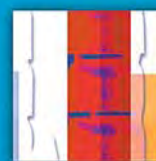

Μονοβάθμιες  
Φυγοκεντρικές Αντλίες  
Single stage  
End-suction Pumps

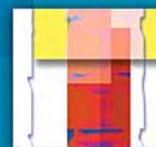

### Χαρακτηριστικά

- Οριζόντιες μη αυτόματης αναρρόφησης μονοβάθμιες φυγοκεντρικές αντλίες, συνδεδεμένες με ηλεκτρικό κινητήρα
- Οριζόντια αναρρόφηση και κατακόρυφη κατάθλιψη στο πάνω μέρος
- Οι φλάντζες αναρρόφησης και κατάθλιψης είναι PN 16, κατάλληλες μέχρι 16 bar, σύμφωνα με EN 733 (DIN 24255)
- Μεγάλο εύρος λειτουργίας
- Η αντλία και ο κινητήρας εδράζονται πάνω σε χαλύβδινη βάση.
- Εύκολη συντήρηση, χωρίς να χρειάζεται μετακίνηση του σώματος της αντλίας ή των σωλήνων κατάθλιψης.

### Απόδοση

- Παροχή μέχρι 4.000 m<sup>3</sup>/h.
- Μανομετρικό μέχρι 100 m.
- Ισχύς ηλεκτροκινητήρα από 0,55 kW μέχρι 450 kW.
- Κινητήρες κλειστού τύπου, αερόψυκτοι, διπολικοί ή τετραπολικοί
- Κλάση μόνωσης F, προστασία IP 55
- Ταχύτητα περ/φής 1750/3500 r.p.m.(60 Hz)
- Διαθέσιμο και στα 50 Hz (1450/2900 r.p.m.)
- Τοποθέτηση κινητήρα B3
- Σύνδεση αντλίας-κινητήρα με ημί-εύκαμπτο κόμπλερ.

### Εφαρμογές

- Παροχή νερού: φιλτράρισμα και μεταφορά νερού σε δίκτυα νερού, σε συνδυασμό με πιεστικά δοχεία σε υψηλά κτίρια
- Βιομηχανικές εφαρμογές: Συστήματα καθαρισμού, πλυντήρια υψηλής πίεσης, πυροσβεστικά
- Βιομηχανικές εφαρμογές: Συστήματα κλιματισμού, θέρμανσης ψύξης
- Άρδευση: Πότισμα αγροτεμαχίων με ψεκασμό ή με σταγονίδια κ.α.

### Features

- Horizontal non-self priming single-stage centrifugal pump, attached with long shaft electric motor
- Horizontal suction and vertical discharge on top
- Discharge and suction flanges are PN16 according to EN 733 (DIN 24255) for maximum operation up to 16 bar
- Wide operation range
- Pump and motor are mounted on steel-base
- Easy maintenance without having to remove pump body or pipeline discharge

### Performance

- Capacity up to 4.000 m<sup>3</sup>/h.
- Head up to 100 m.
- Rated motor power output 0,55 kW up to 450 kW.
- TEFC, 2-pole or 4-pole standard motor
- Class F insulation, IP 55 protection
- Rotation speed 1750/3500 r.p.m.(60 Hz)
- Available at 50 Hz (1450/2900 r.p.m.)
- Mounting B3
- Pump and motor connection with semi-flexible coupling

### Applications

- Water supply: Water filter and transport in Waterworks, boosting of main pipeline, boosting in high-rise buildings.
- Industrial boosting: Cleaning system, high-pressure washing system, fire fighting system
- Industrial: cooling and air-conditioning systems
- Irrigation: Farmland irrigation, spray irrigation, dripping irrigation

Code 10417091

## Αναγνώριση

Το παράδειγμα δείχνει μία αντλία:  
MKT 50-200/193, με πτερωτή από χυτοσίδηρο  
με φλάντζα κατάθλιψης DN50,  
διάμετρο πτερωτής 193mm

### Παράδειγμα

**MKT 50-200/193**

Τύπος (MKT ή MBT ή MST για πτερωτή από χυτοσίδηρο ή ορείχαλκο ή ανοξείδωτο χ.)

Ονομαστική Φλάντζα κατάθλιψης (DN)

Ονομαστική Διάμετρος πτερωτής (mm)

Διάμετρος πτερωτής (mm)

## Identification

The example shows a pump:  
MK 50-200/193,  
Of discharge flange DN50,  
Impeller diameter 193mm

### Example

**MKT 50-200/193**

Type (MKT or MBT or MST for impeller made of cast iron or bronze or stainless steel)

Nominal Discharge flange DN

Nominal Impeller Diameter (mm)

Impeller Diameter (mm)

## Τομή MKT

### Section view MKT

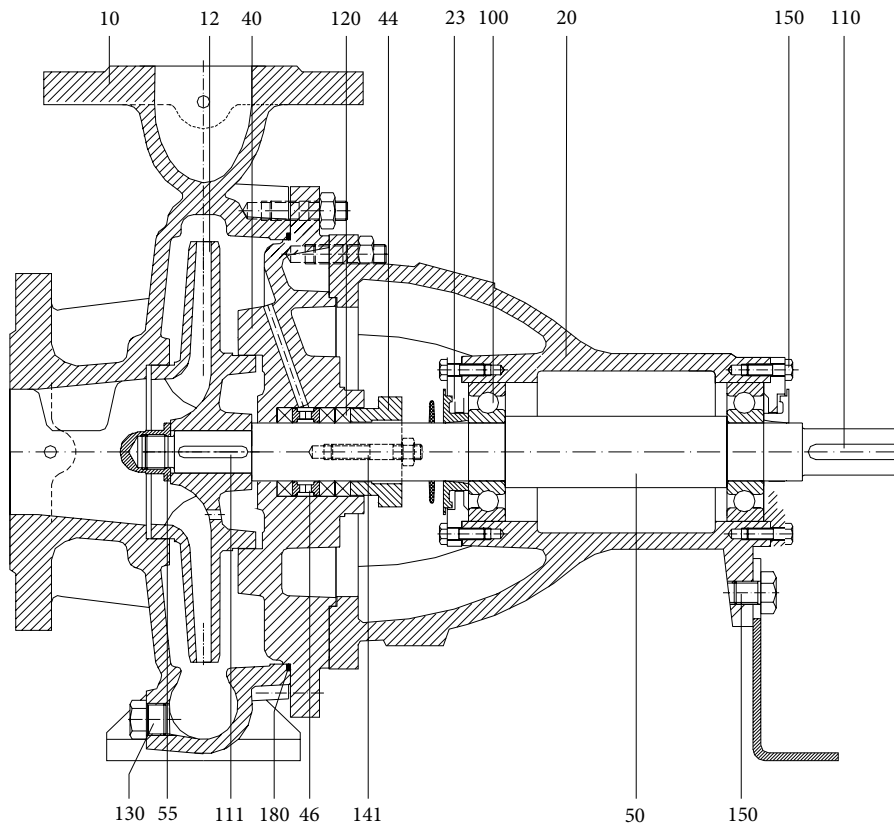

N.	Περιγραφή Description	Υλικό Material	N.	Περιγραφή Description
10	Κέλυφος αντλίας Pump Casing	Standard-GG 25 Option -GGG40, Bronze, AISI304, AISI316	100	Έδρανο Bearing
12	Πτερωτή Impeller		110	Σφήνα άξονα Shaft key
20	Φώλια Bearing housing		111	Σφήνα πτερωτής Impeller key
23	Καπάκι Φώλιας Bearing housing cover		120	Σαλαμάστρα Gland
40	Βάση Στυπιοθλίπτης Packing box		130	Τάπα αποστράγγισης Drain plug
44	Στυπιοθλίπτης Gland	Standard-GGG40 Option-GG25, Bronze, AISI304, AISI316	141	Μπουζόνι Stud
46	Προστατευτικός δακτύλιος Lantern Ring		150	Βίδα Bolt
50	Άξονας Shaft	Standard-AISI420 Option-AISI304, AISI316	180	O-ring
55	Περικόχλιο Άξονα Shaft nut			

## Διαστασιολόγιο MKT Dimension MKT

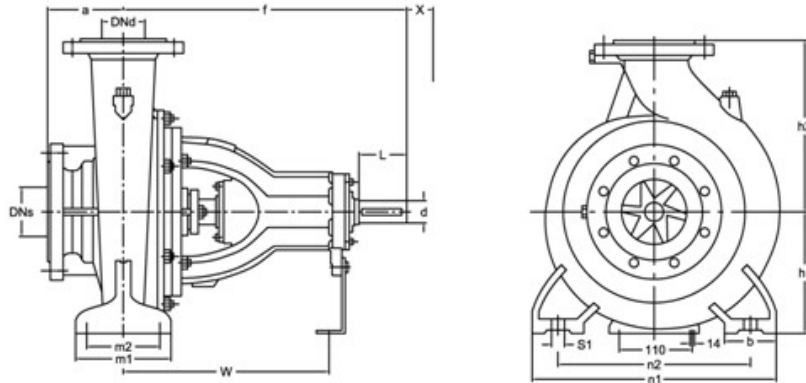

PUMP Type DIN 24255	Ports		Length		Height		Pump Dimension						Shaft End		X	Weight [kg]	
	DNs	DNd	a	f	h1	h2	b	m1	m2	n1	n2	s1	W	d			l
	[mm]																
32-160	50	32	80	360	132	160	50	100	70	240	190	M12	260	24	50	65	37
32-200	50	32	80	360	160	180	50	100	70	240	190	M12	260	24	50	65	40
32-250*	50	32	100	360	180	225	65	125	95	320	250	M12	260	24	50	80	45
40-160	65	40	80	360	132	160	50	100	70	240	190	M12	260	24	50	75	38
40-200	65	40	100	360	160	180	50	100	70	265	212	M12	260	24	50	75	44.5
40-250	65	40	100	360	180	225	65	125	95	320	250	M12	260	24	50	75	54
50-160	65	50	100	360	160	180	50	100	70	265	212	M12	260	24	50	80	41.5
50-200	65	50	100	360	160	200	50	100	70	265	212	M12	260	24	50	85	46.5
50-250	65	50	100	360	180	225	65	125	95	320	250	M12	260	24	50	85	54.5
50-315*	80	50	100	470	225	280	80	160	120	360	280	M16	330	32	80	100	103
65-160	80	65	100	360	160	200	65	125	95	280	212	M12	260	24	50	100	44
65-200	80	65	100	360	180	225	65	125	95	320	250	M12	260	24	50	100	47.5
65-250	80	65	100	470	200	250	80	160	120	360	280	M16	340	32	80	100	77.5
65-315	80	65	125	470	225	280	80	160	120	400	315	M16	340	32	80	110	92
65-400*	100	65	125	470	250	355	80	160	120	400	315	M16	340	32	80	110	125
80-160	100	80	125	360	180	225	65	125	95	320	250	M12	260	24	50	110	51
80-200	100	80	125	470	180	250	65	125	95	345	280	M12	340	32	80	110	75.5
80-250	100	80	125	470	200	280	80	160	120	400	315	M16	340	32	80	115	93
80-315	100	80	125	470	250	315	80	160	120	400	315	M16	340	32	80	120	107
80-400*	100	80	125	530	280	355	100	200	150	500	400	M20	370	42	110	120	162
100-160*	125	100	125	360	200	280	80	160	1200	360	280	M16	260	24	50	120	70
100-200	125	100	125	470	200	280	80	160	120	360	280	M16	340	32	80	120	83
100-250	125	100	140	470	225	280	80	160	120	400	315	M16	340	32	80	130	95
100-315	125	100	140	470	250	315	80	160	120	400	315	M16	340	32	80	130	110
100-400	125	100	140	530	280	355	100	200	150	500	400	M20	370	42	110	130	168
125-200*	150	125	140	470	250	315	80	160	120	400	315	M16	340	32	80	130	106.5
125-250	150	125	140	470	250	355	80	160	120	400	315	M16	340	32	80	140	105.5
125-315	150	125	140	530	280	355	100	200	150	500	400	M20	370	42	110	140	166.5
125-400	150	125	140	530	315	400	100	200	150	500	400	M20	370	42	110	140	189
150-200*	200	150	160	470	280	355	100	200	150	500	400	M16	340	32	80	170	137.5
150-250*	200	150	160	470	280	375	100	200	150	500	400	M16	340	32	80	140	137.5
150-315	200	150	160	530	280	400	100	200	150	550	450	M20	370	42	110	140	182.5
150-400	200	150	160	530	315	450	100	200	150	550	450	M20	370	42	110	140	210.5
150-500*	200	150	180	700	400	525	110	250	200	620	500	M20	500	55	110	140	197
200-280*	250	200	200	560	355	450	110	250	200	620	500	M20	410	42	110	200	300
200-315*	250	200	180	535	355	450	110	250	200	620	500	M20	410	42	110	160	201
200-400*	250	200	180	710	400	500	110	250	200	620	500	M20	500	55	110	160	354
200-500*	250	200	210	850	400	550	140	300	240	720	600	M24	600	65	140	160	520
250-315*	300	250	240	725	400	525	140	300	240	620	500	M24	500	55	110	200	419
250-400*	300	250	225	865	400	550	140	300	240	620	500	M24	600	65	140	200	510
250-500*	300	250	280	875	500	700	150	360	290	900	750	M28	560	65	140	320	615
250-500A*	300	250	225	865	450	630	160	300	240	720	600	M24	600	65	140	200	615
300-315*	300	300	275	810	425	600	140	300	240	620	500	M24	550	55	140	270	516
300-400*	350	300	275	865	450	630	150	360	290	800	650	M24	550	65	140	300	636
350-450*	400	350	280	875	500	700	150	360	290	900	750	M24	560	65	140	300	755

\* Pumps not included in DIN 24255. These are extra pumps added to our range.

**Αποδόσεις σε/ Performance at 1750 r.p.m. 50 Hz**

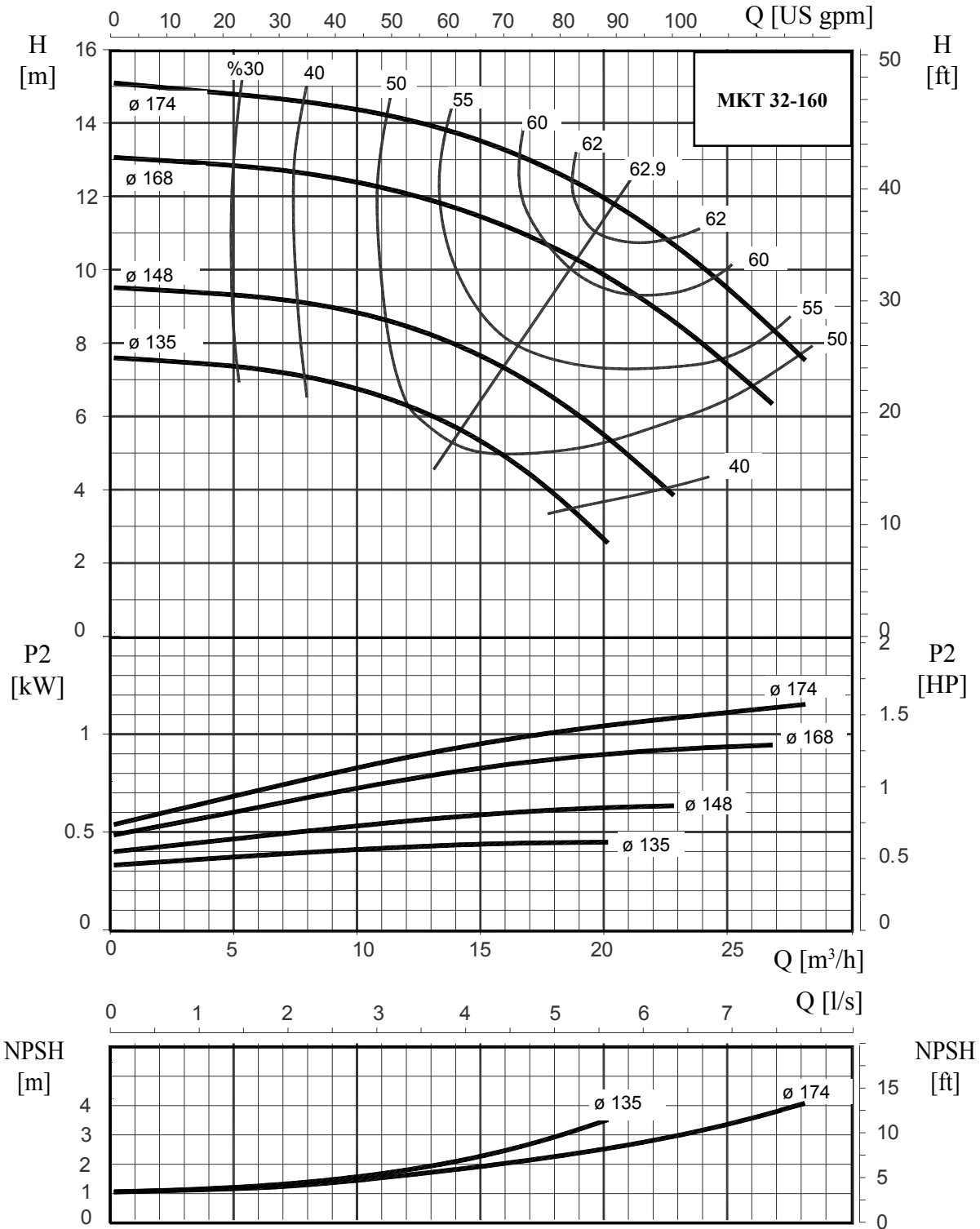

**Αποδόσεις σε/ Performance at 3500 r.p.m. 60 Hz**

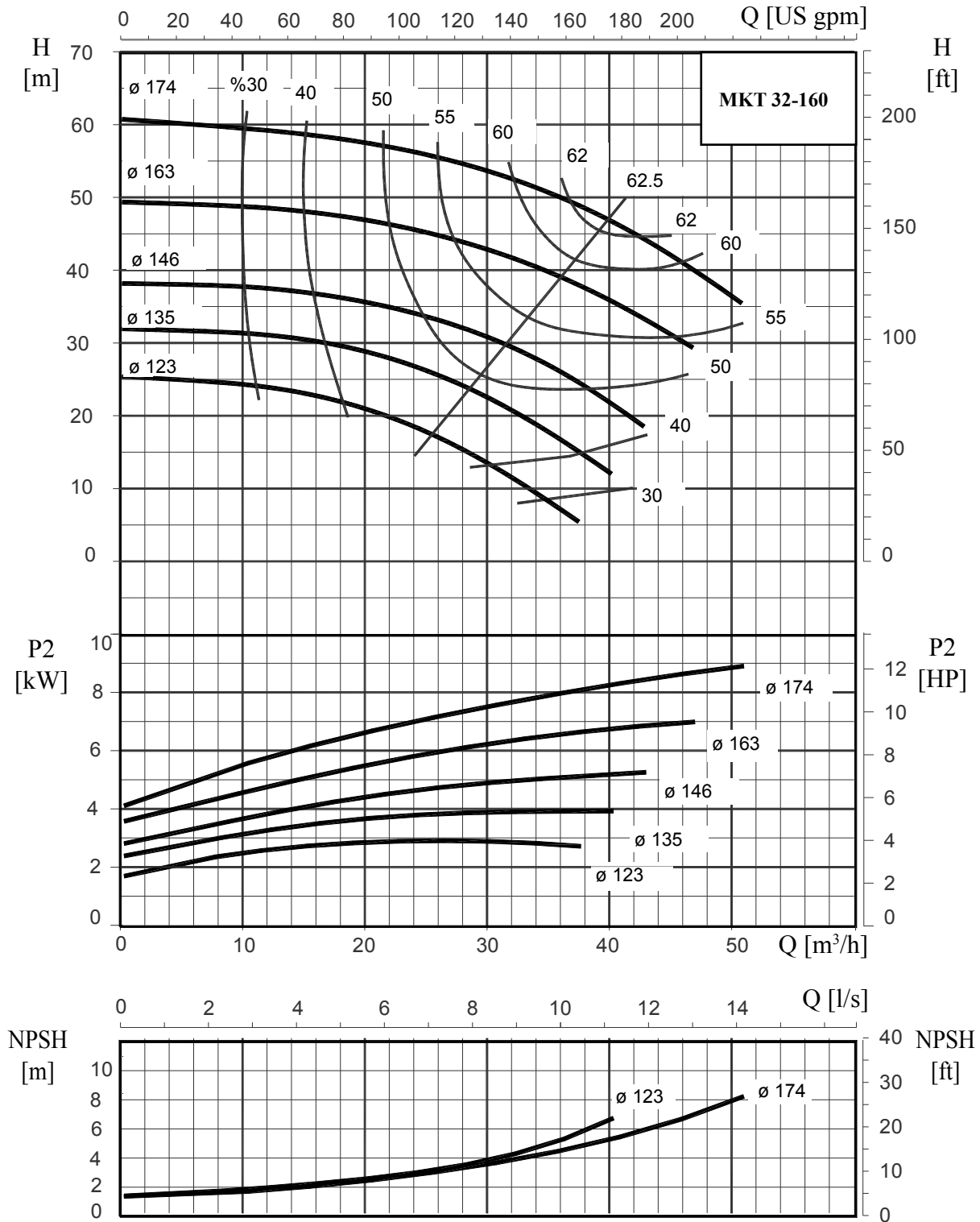

**Αποδόσεις σε/ Performance at 1750 r.p.m. 60 Hz**

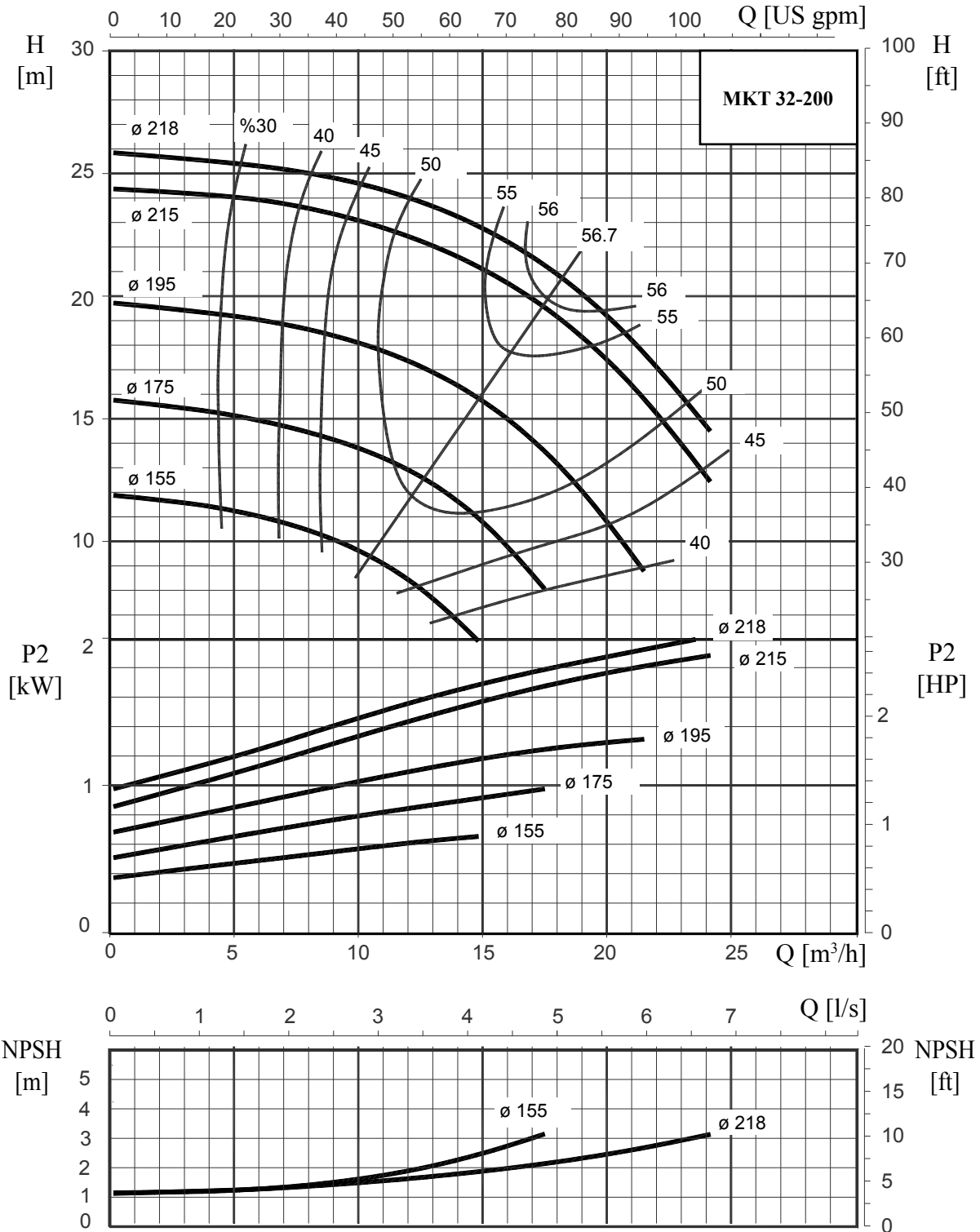



**Αποδόσεις σε/ Performance at 3500 r.p.m. 60 Hz**

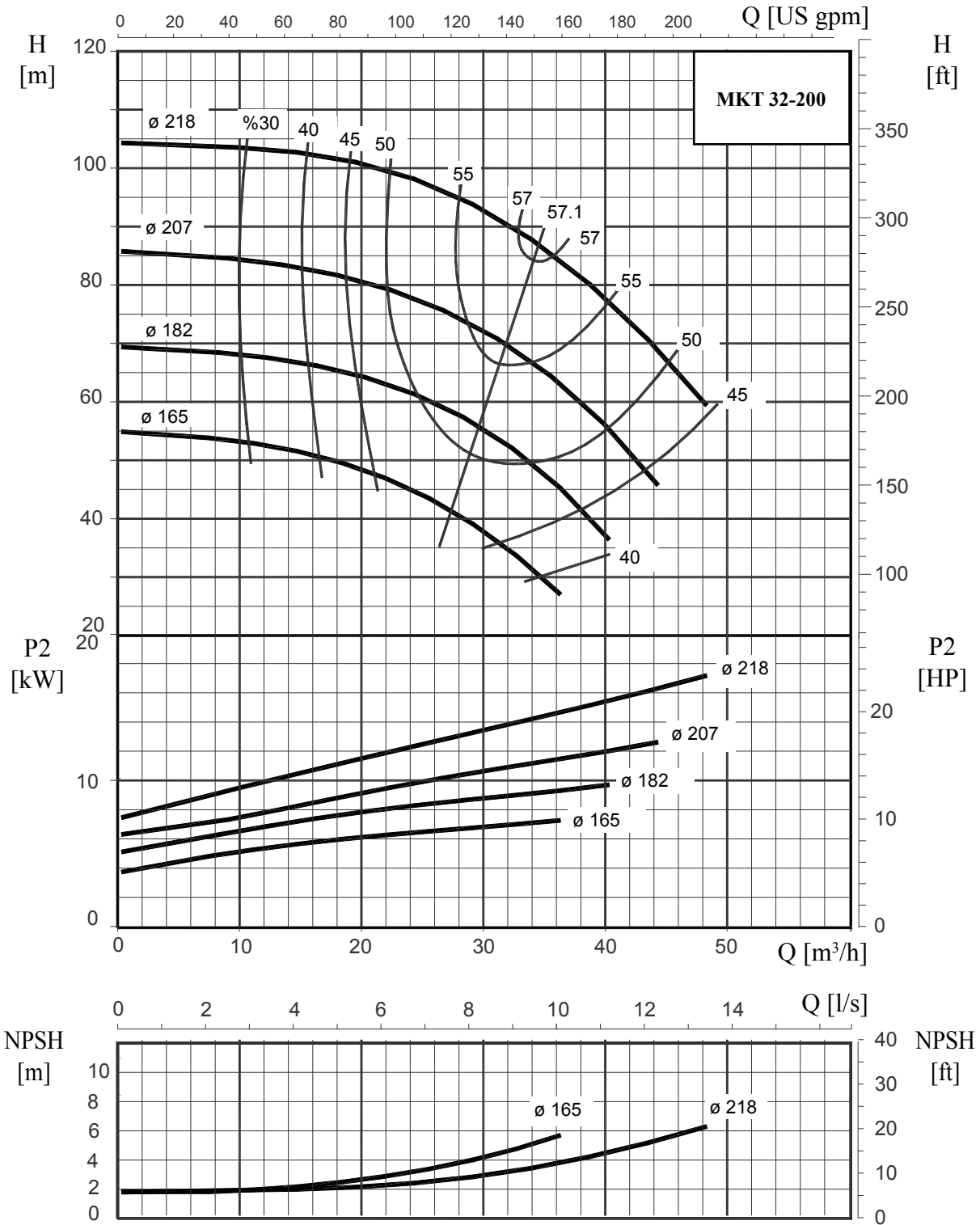

**Αποδόσεις σε/ Performance at 1750 r.p.m. 60 Hz**

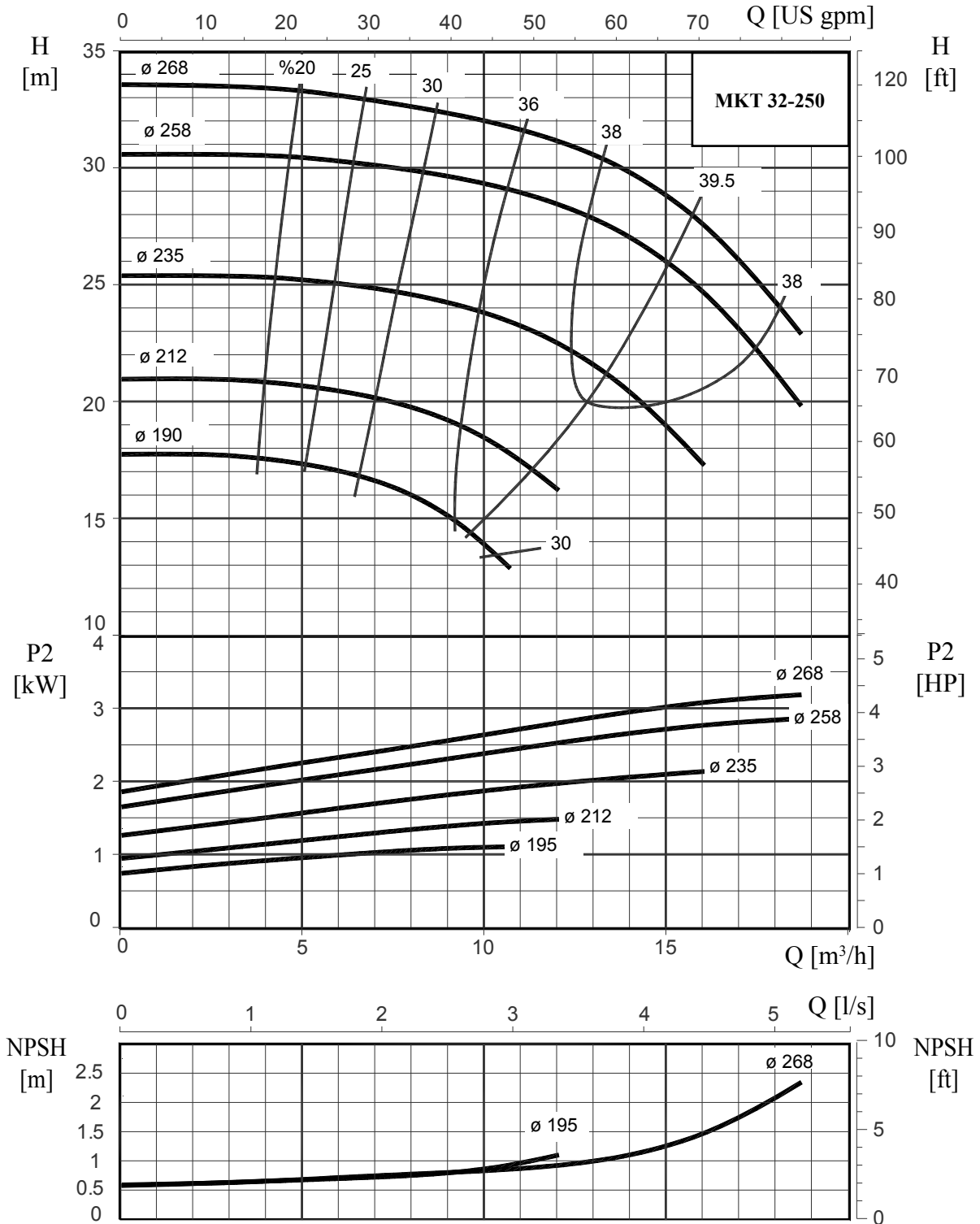

**Αποδόσεις σε/ Performance at 3500 r.p.m. 60 Hz**

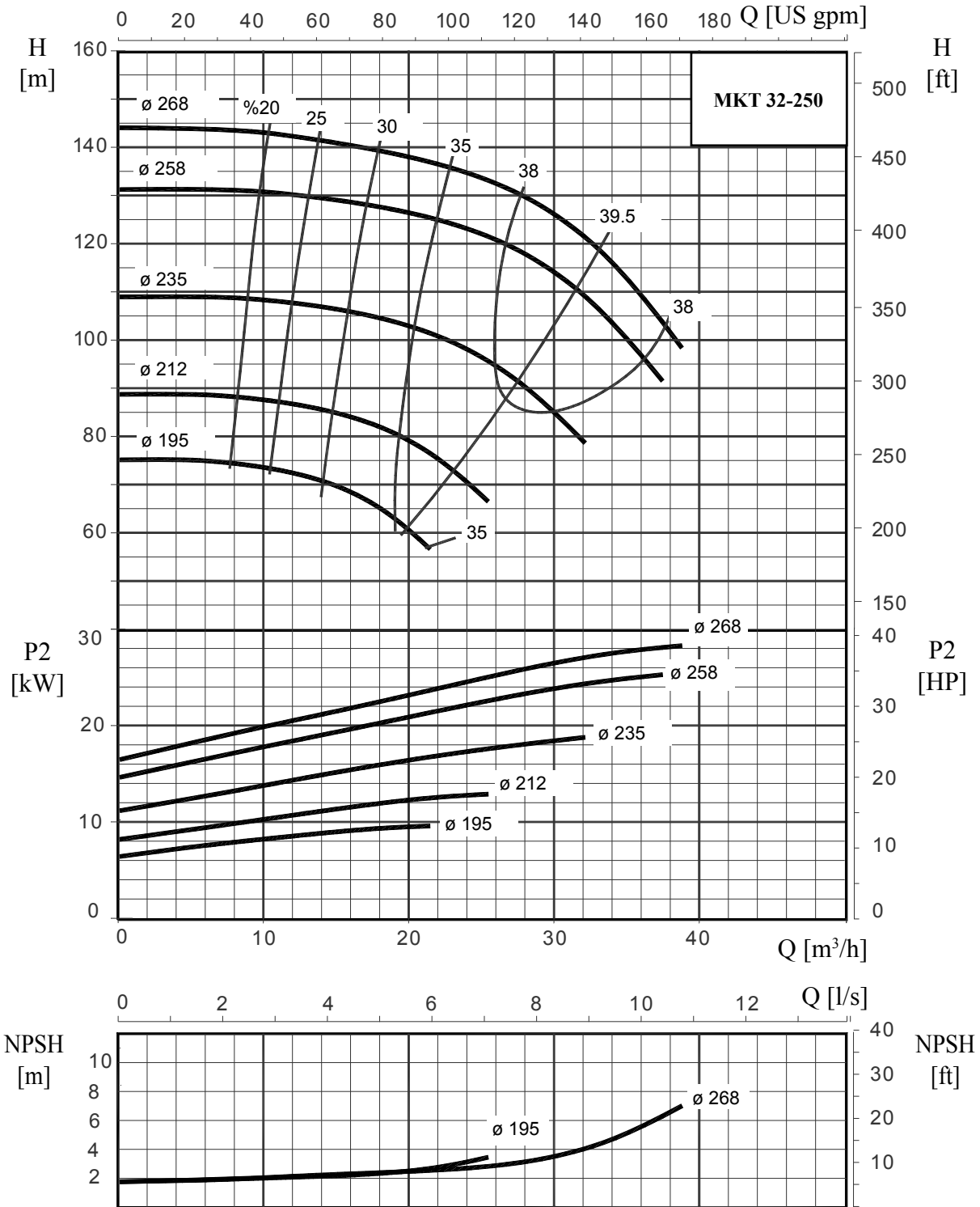

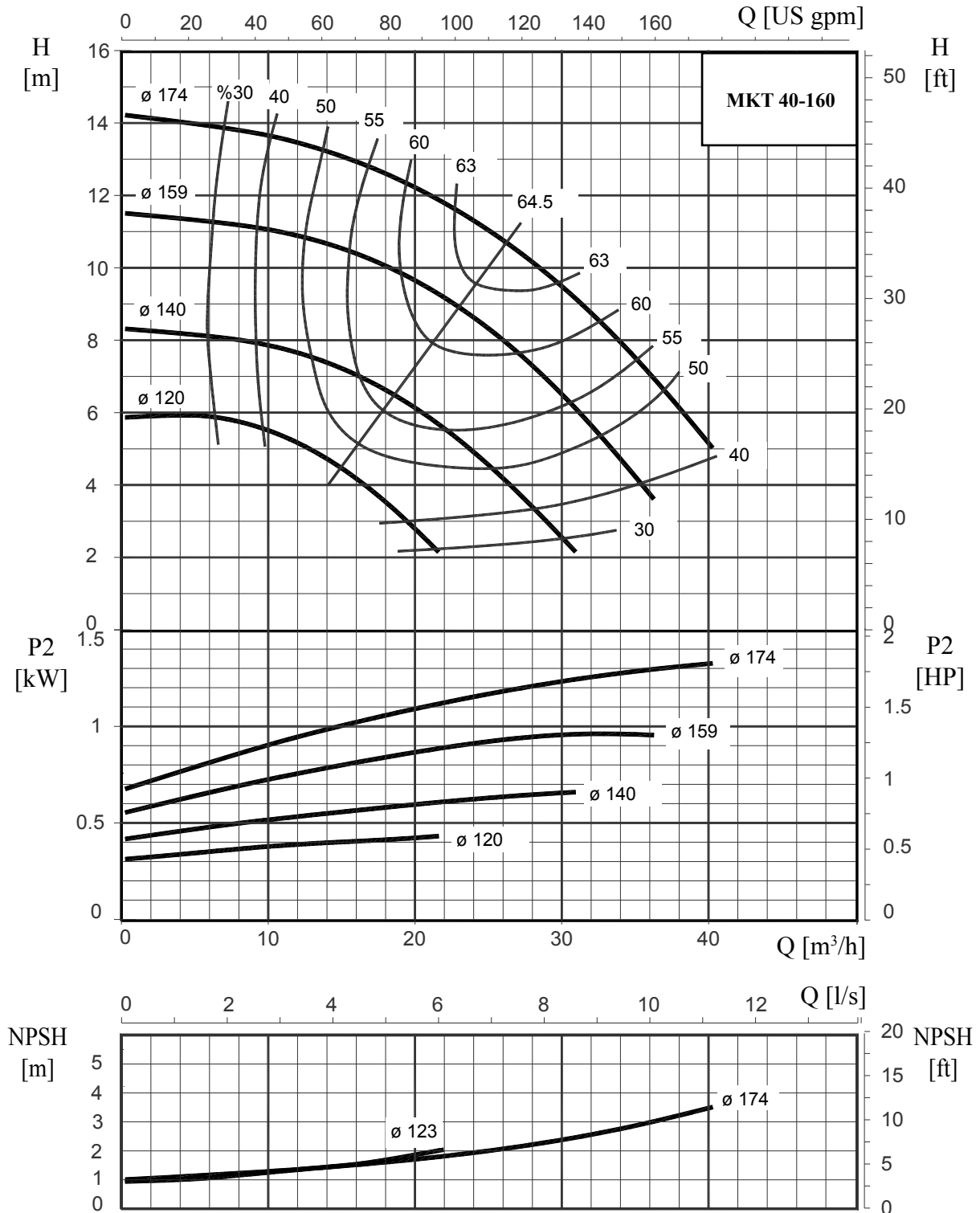
**Αποδόσεις σε/ Performance at 1750 r.p.m. 60 Hz**

**Αποδόσεις σε/ Performance at 3500 r.p.m. 60 Hz**

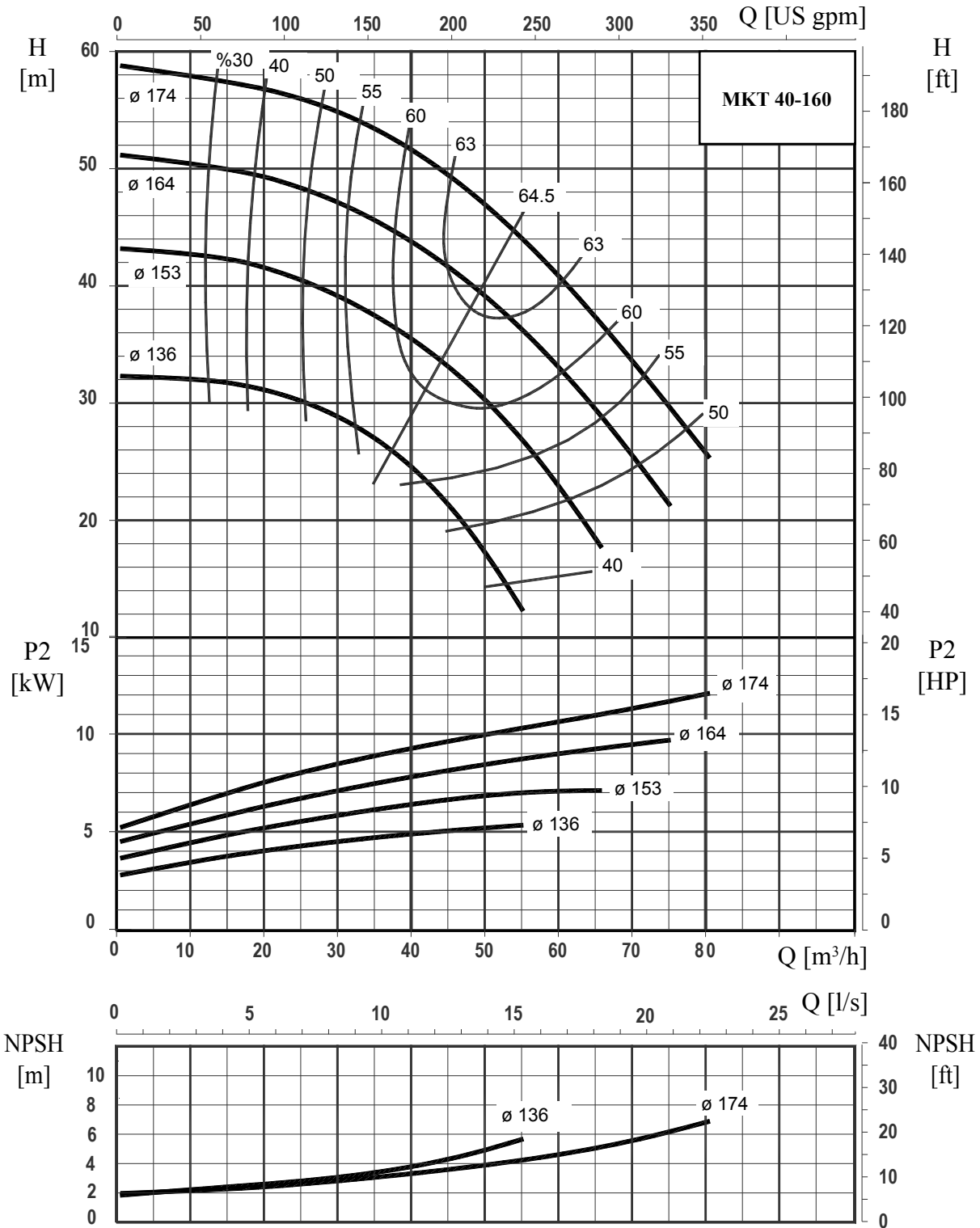

**Αποδόσεις σε/ Performance at 1750 r.p.m. 60 Hz**

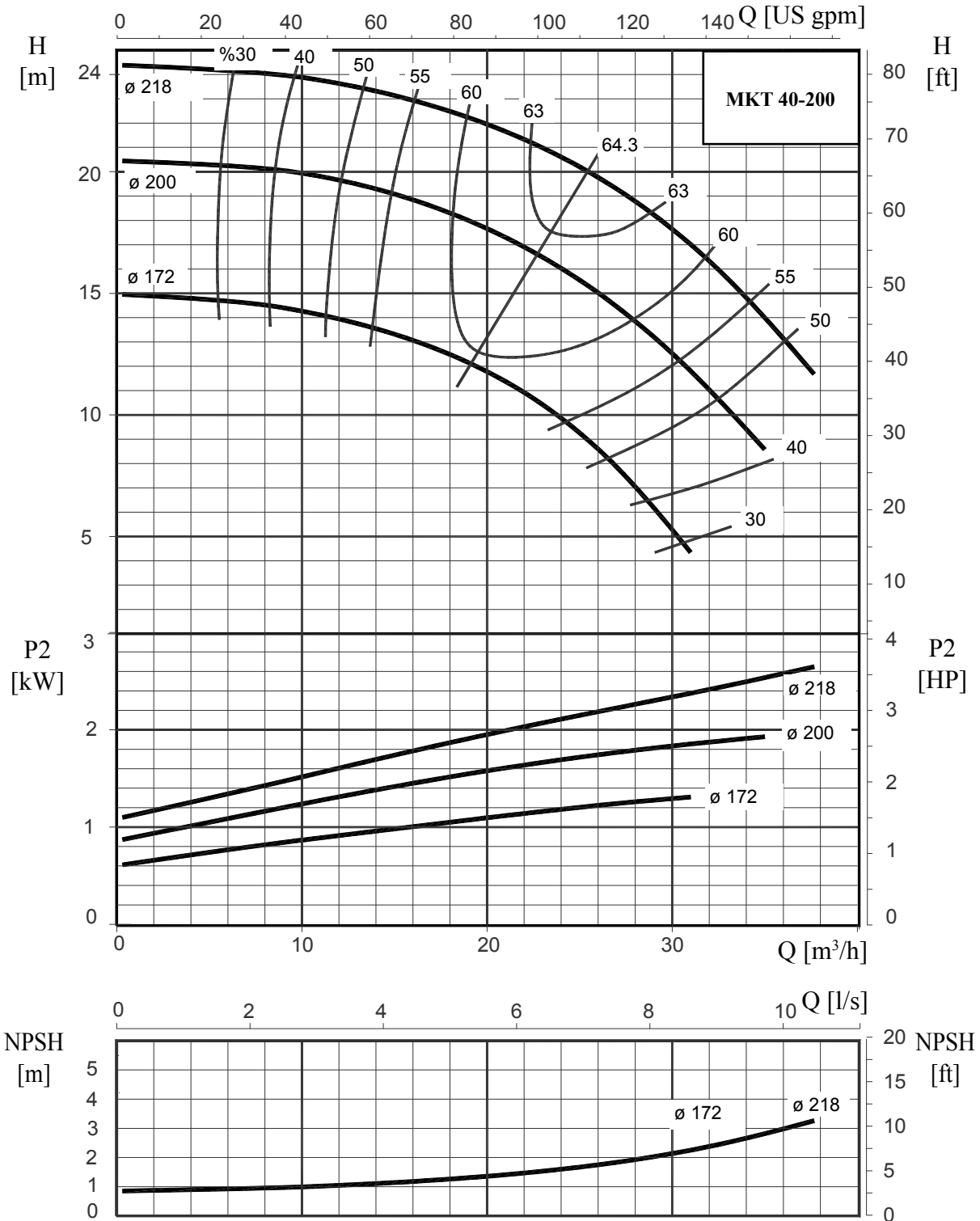

**Αποδόσεις σε/ Performance at 3500 r.p.m. 60 Hz**

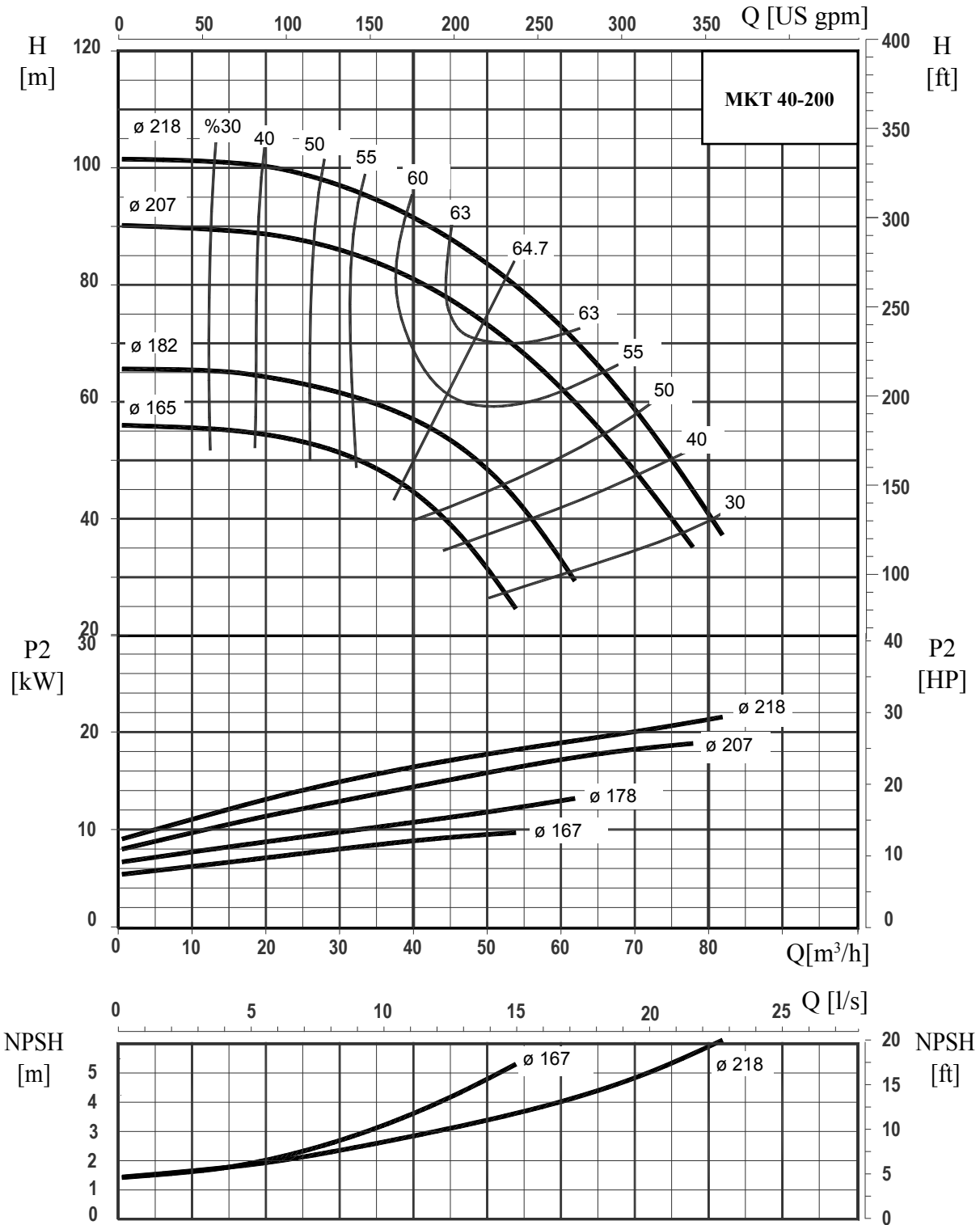

**Αποδόσεις σε/ Performance at 1750 r.p.m. 60 Hz**

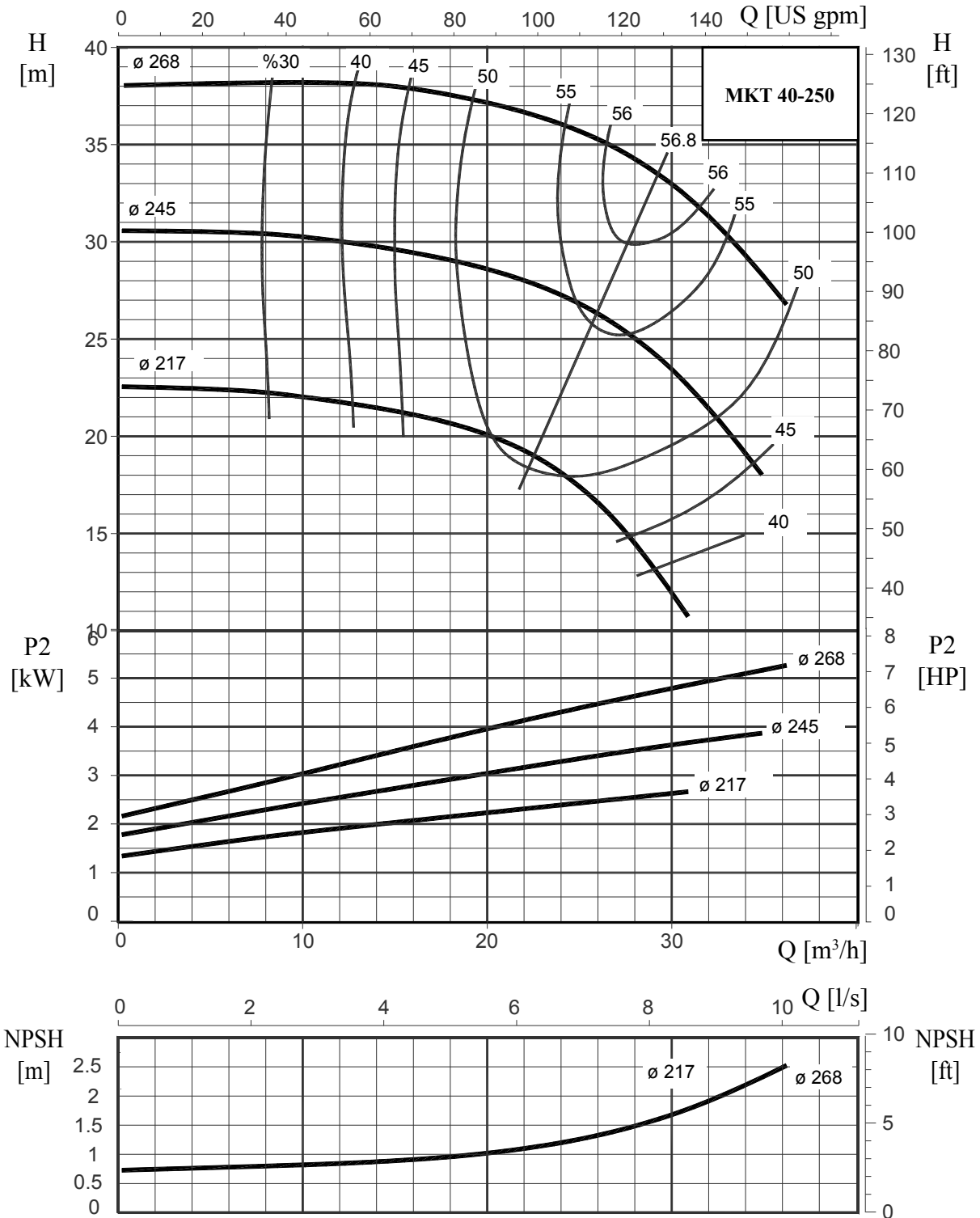

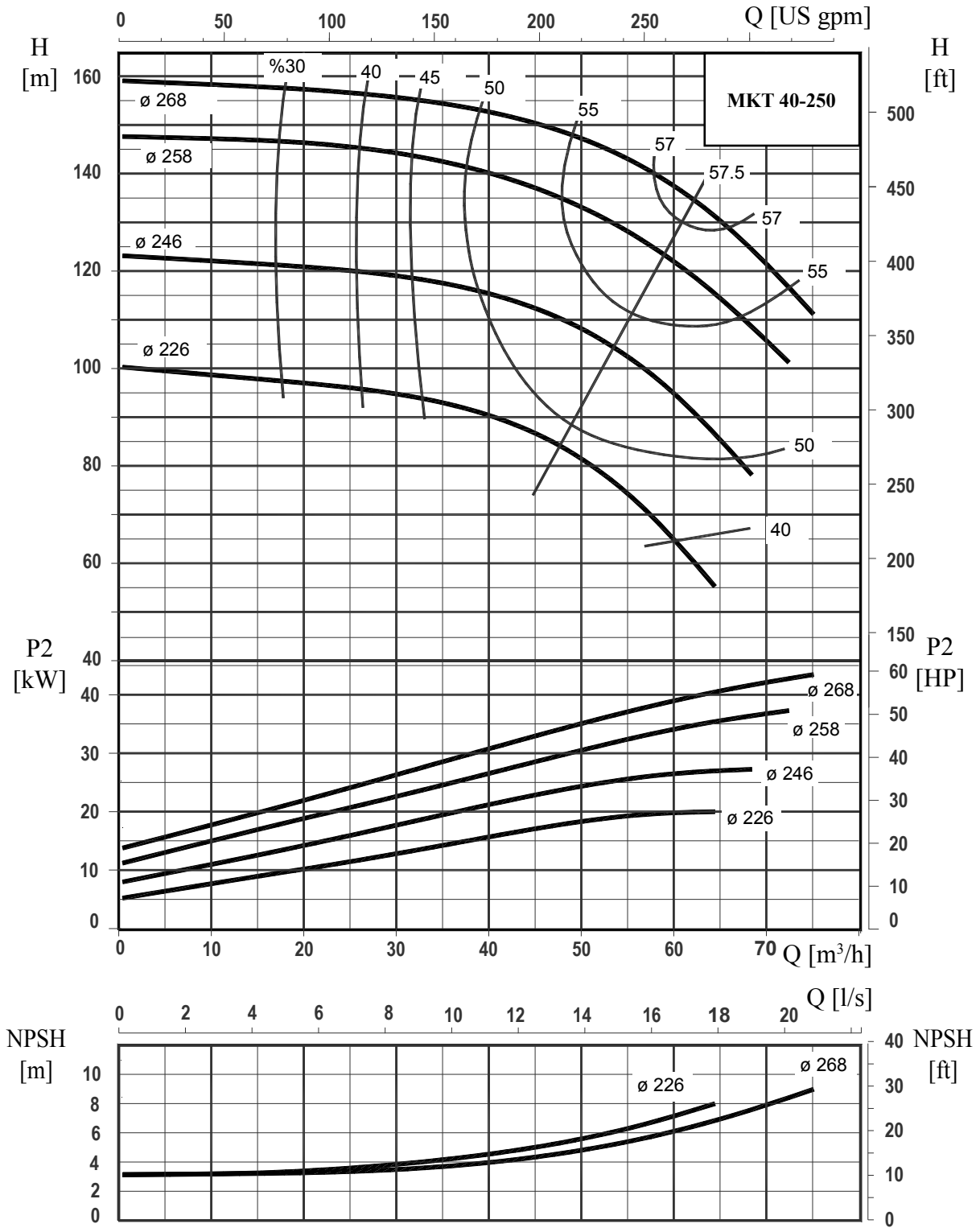

**Αποδόσεις σε/ Performance at 3500 r.p.m. 60 Hz**

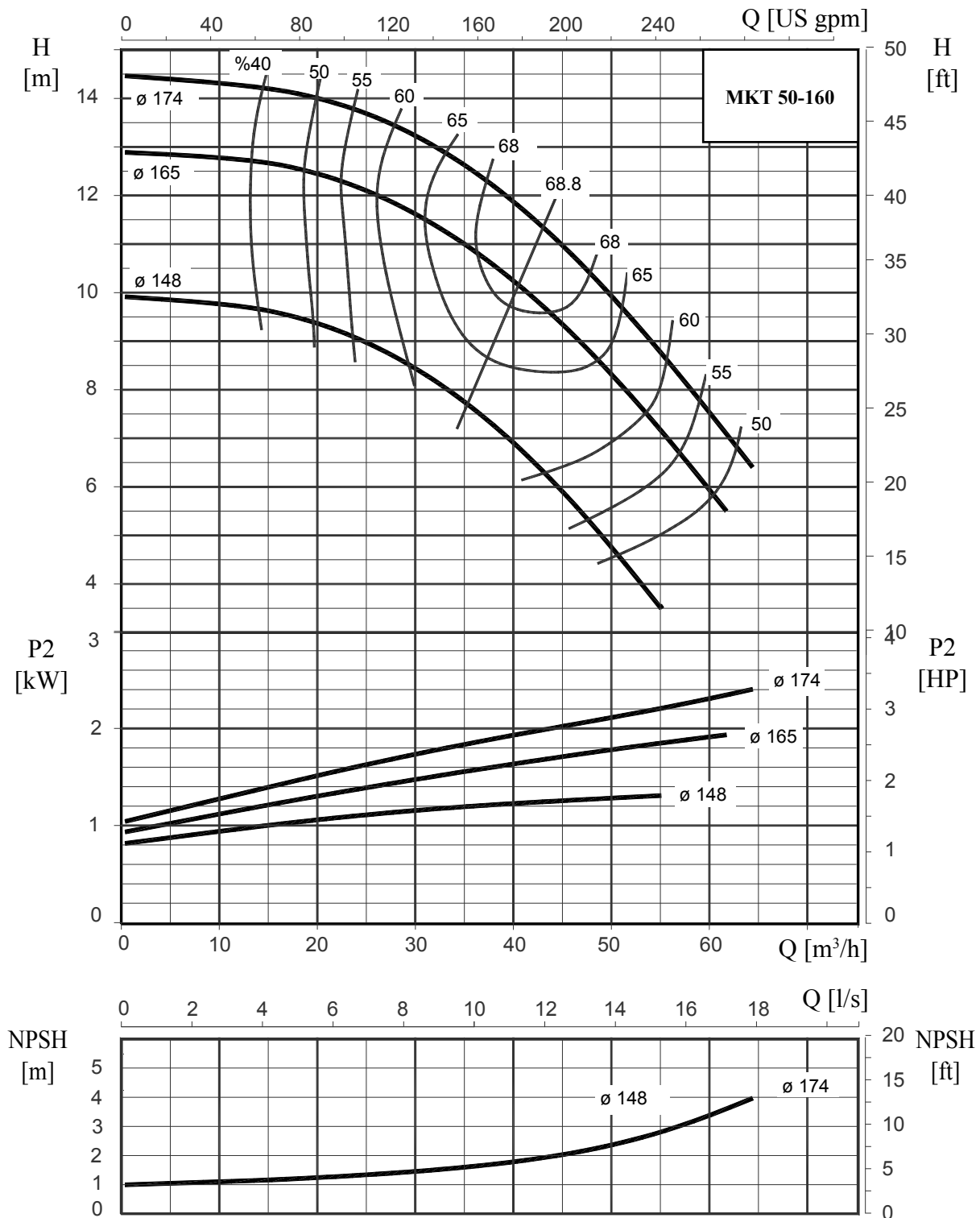
**Αποδόσεις σε/ Performance at 1750 r.p.m. 60 Hz**

**Αποδόσεις σε/ Performance at 3500 r.p.m. 60 Hz**

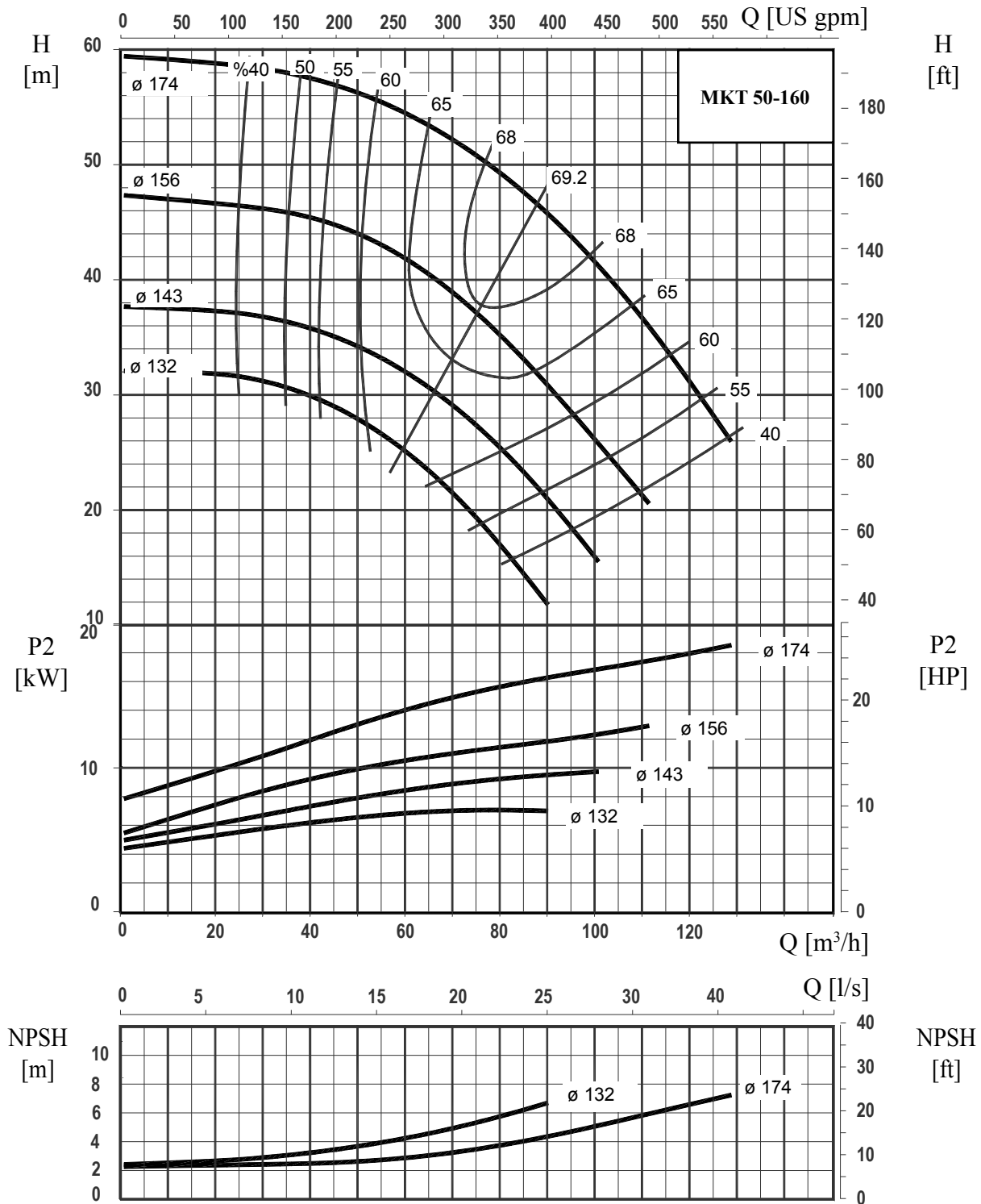

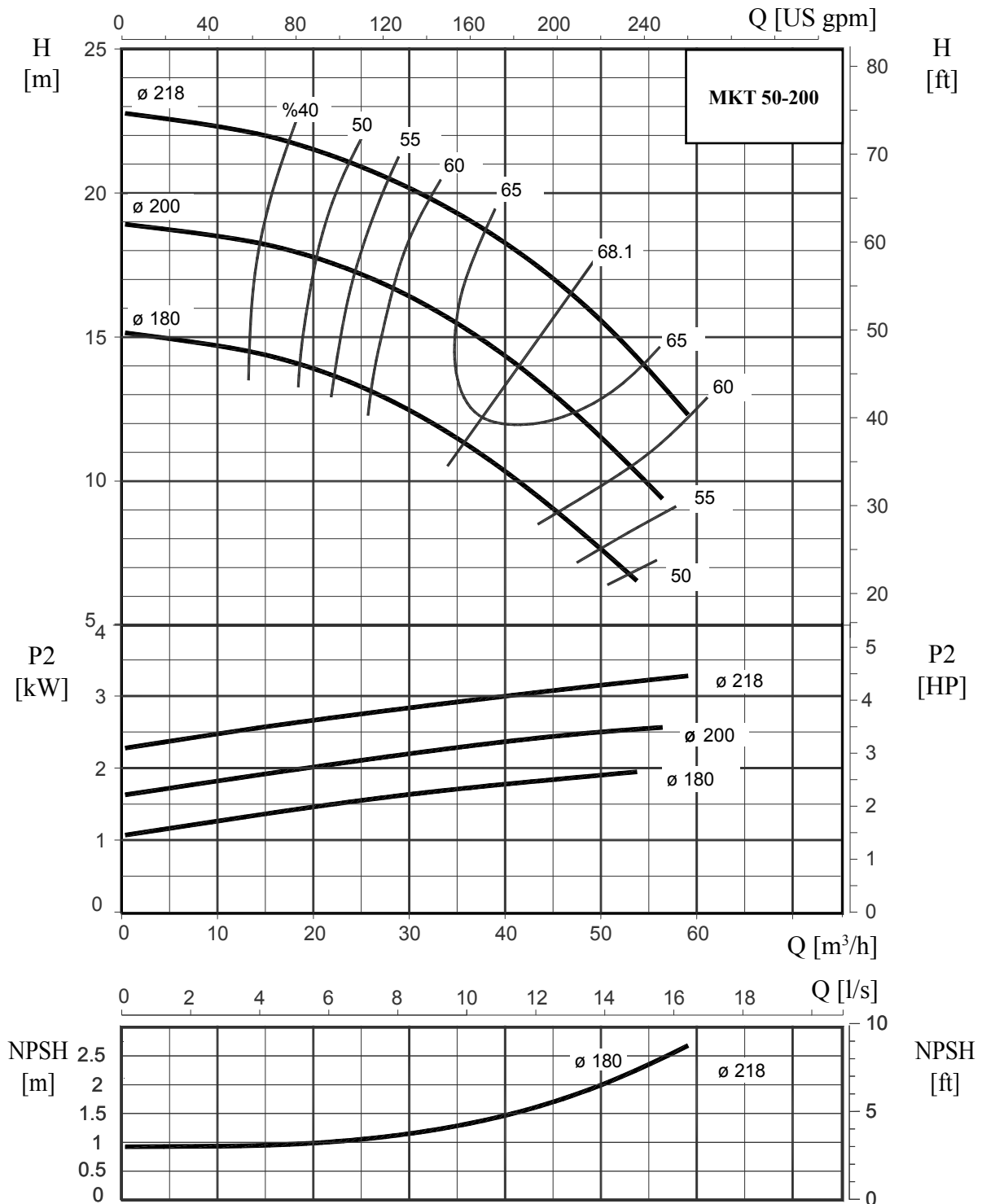
**Αποδόσεις σε/ Performance at 1750 r.p.m. 60 Hz**

**Αποδόσεις σε/ Performance at 3500 r.p.m. 60 Hz**

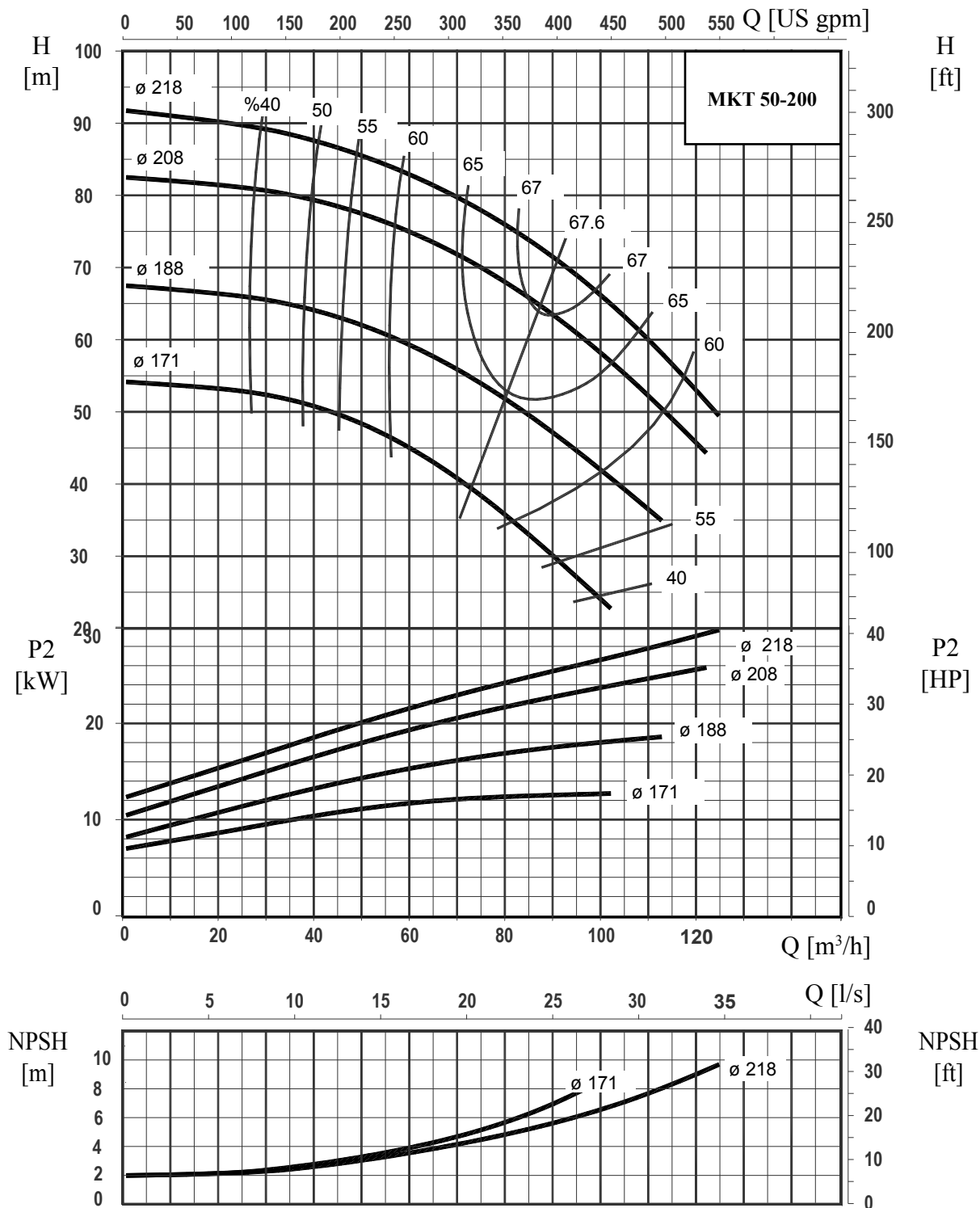

**Αποδόσεις σε/ Performance at 1750 r.p.m. 60 Hz**

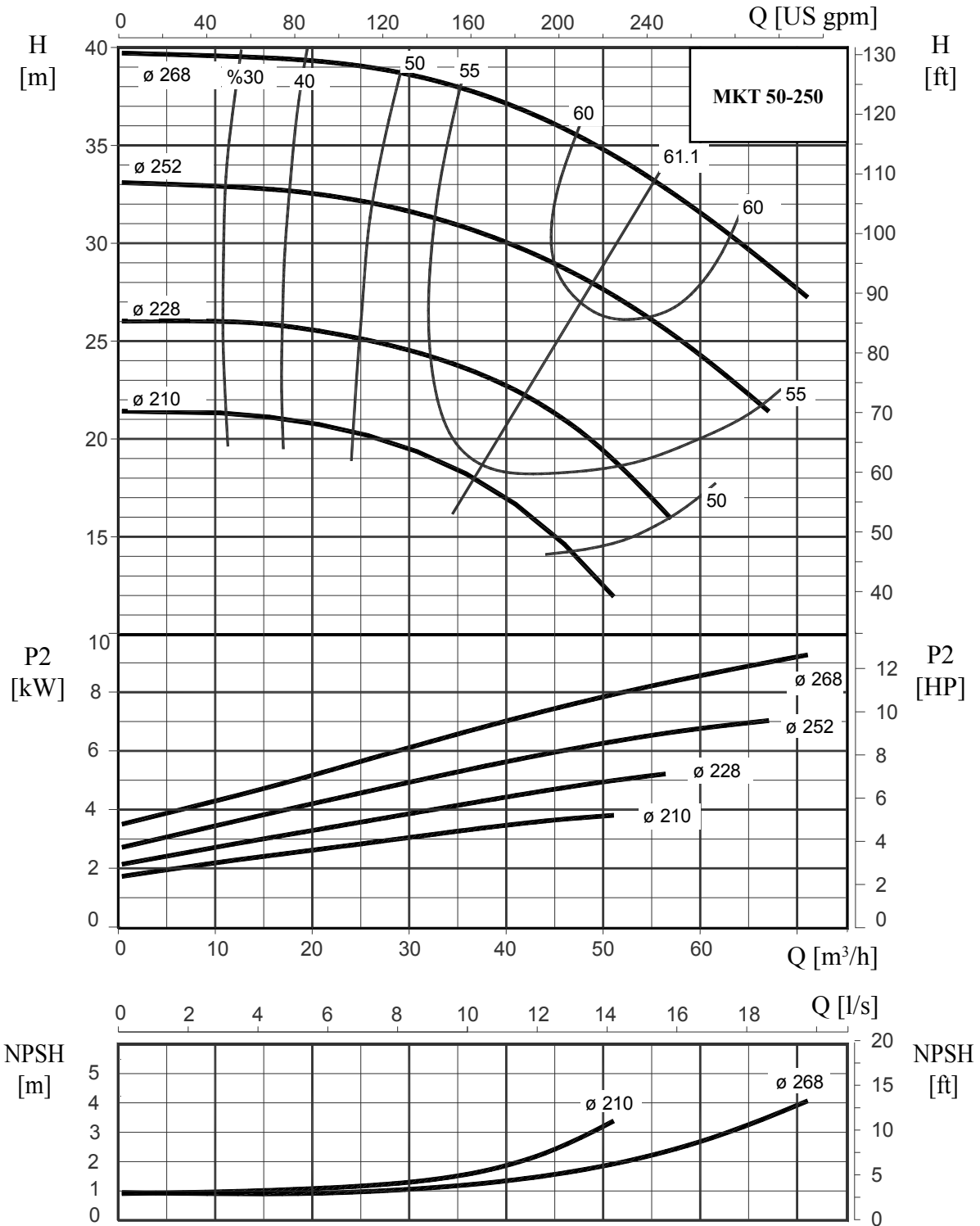

**Αποδόσεις σε/ Performance at 3500 r.p.m. 60 Hz**

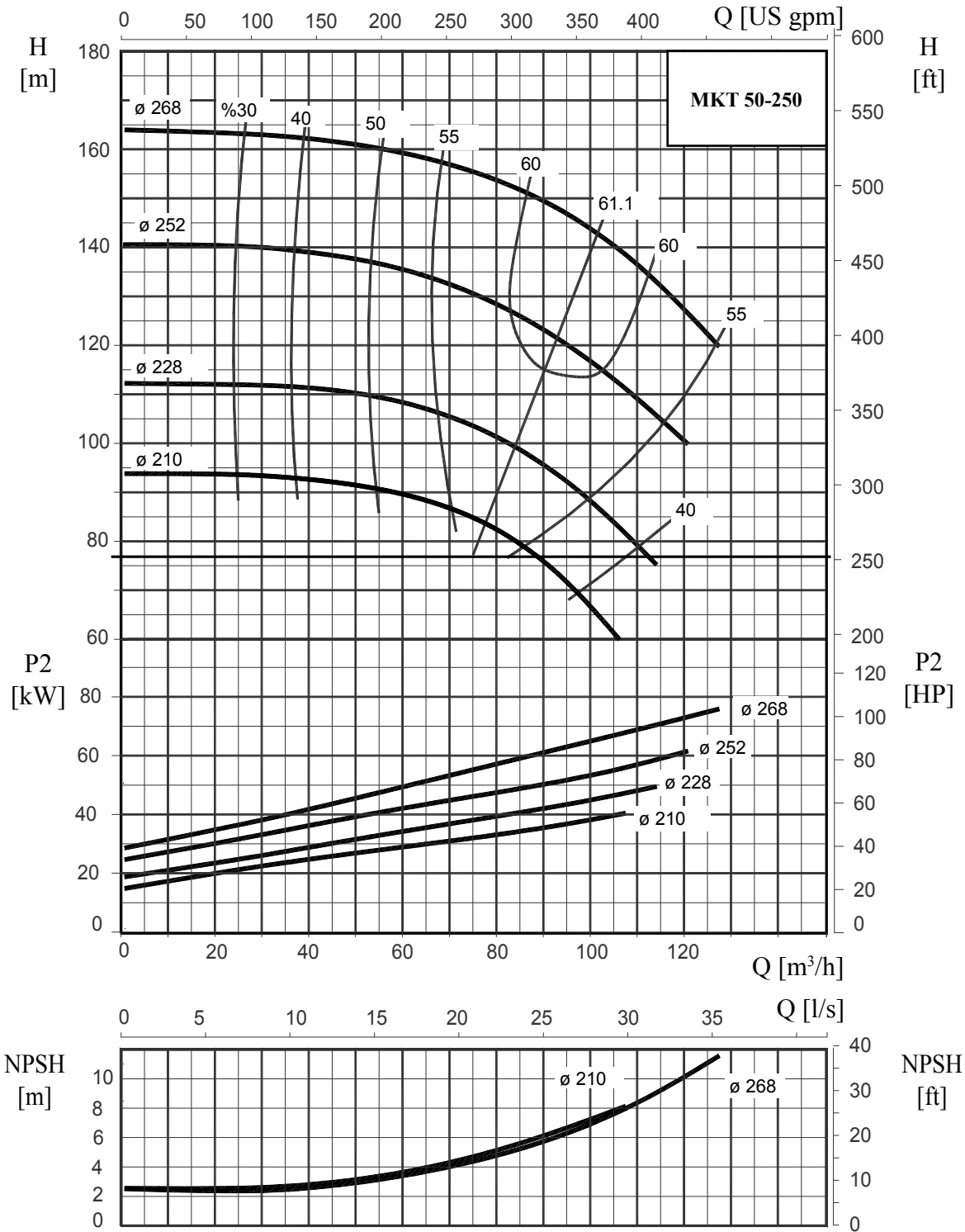

**Αποδόσεις σε/ Performance at 1750 r.p.m. 60 Hz**

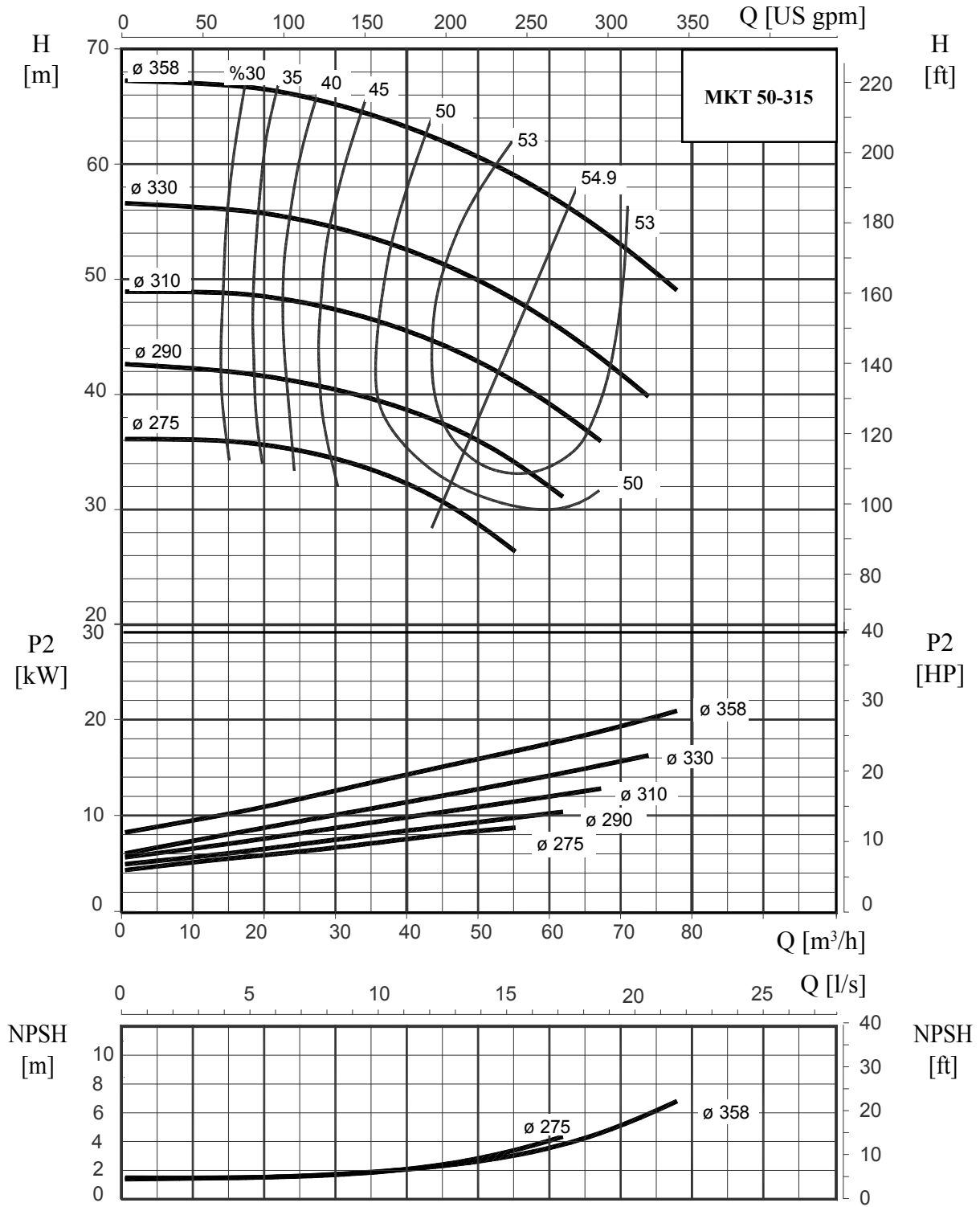



**Αποδόσεις σε/ Performance at 1750 r.p.m. 60 Hz**

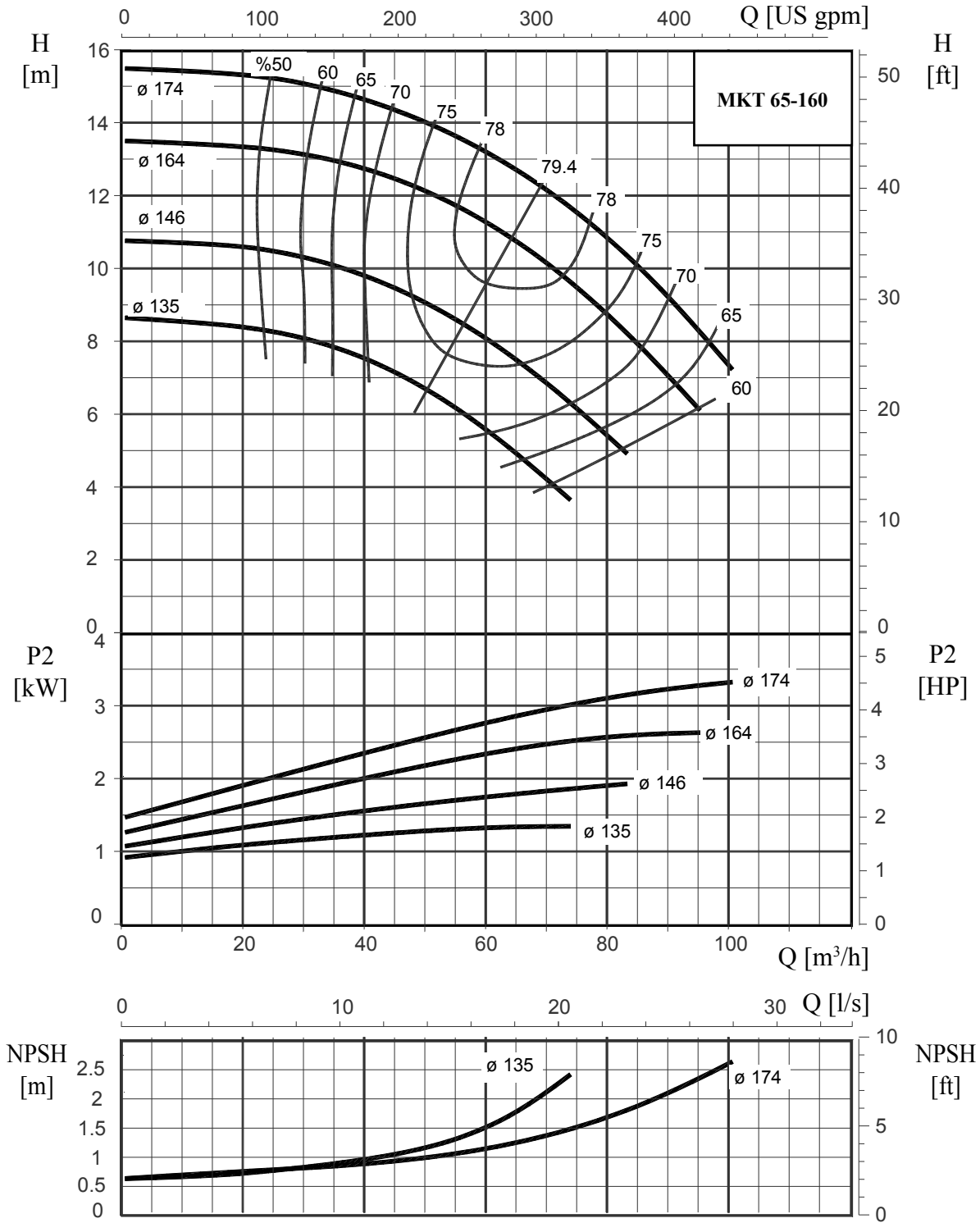

**Αποδόσεις σε/ Performance at 3500 r.p.m. 60 Hz**

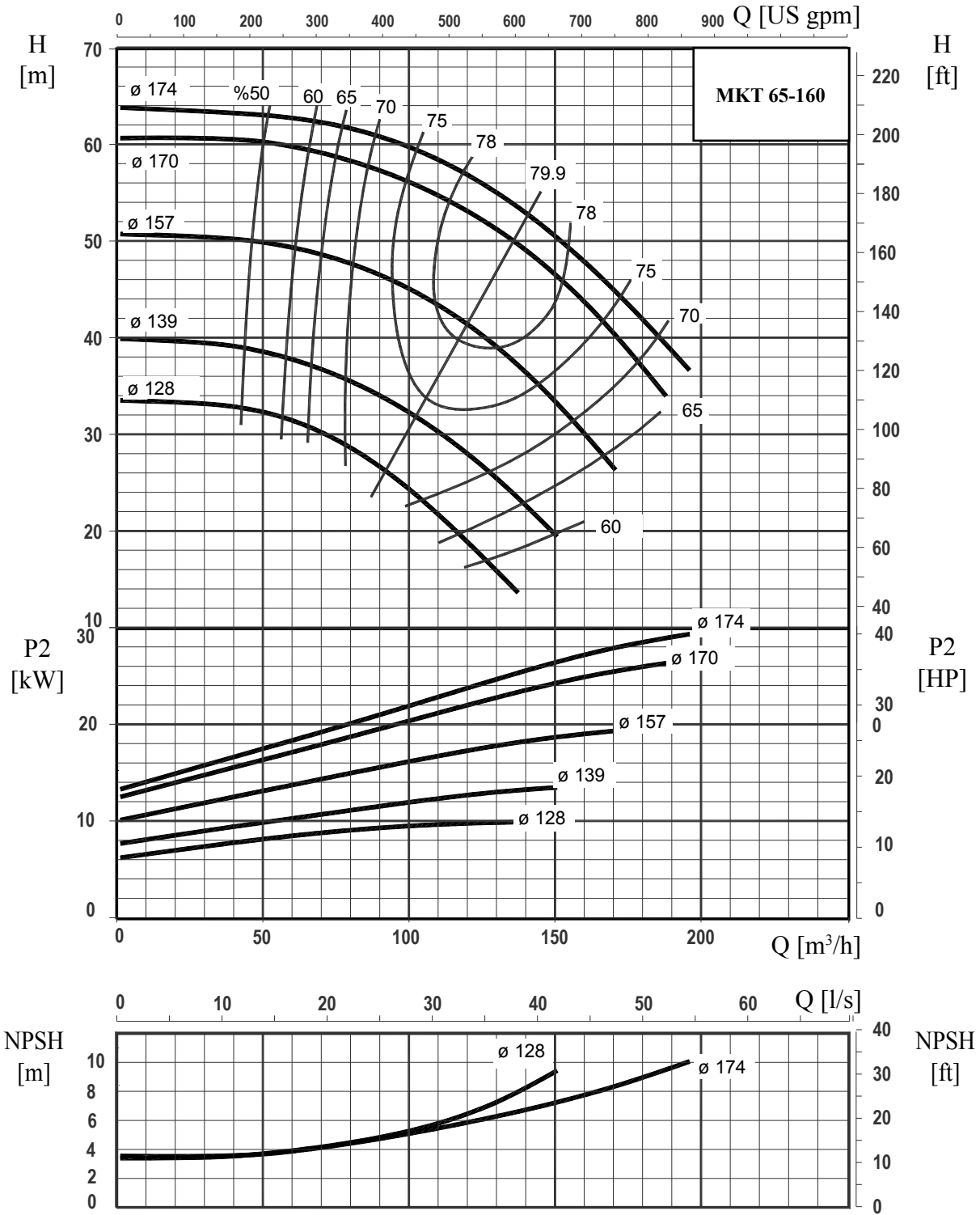

**Αποδόσεις σε/ Performance at 1750 r.p.m. 60 Hz**

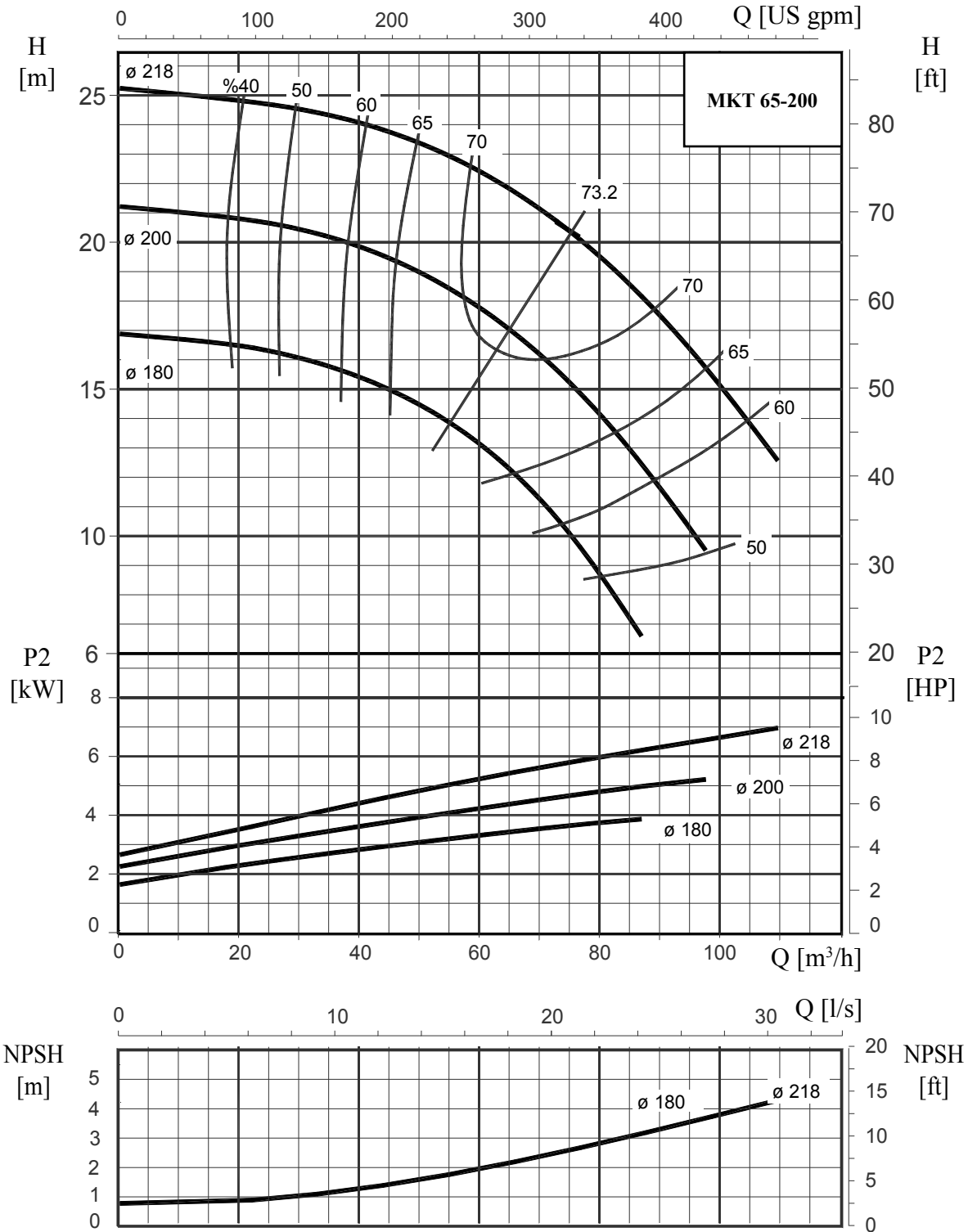

**Αποδόσεις σε/ Performance at 3500 r.p.m. 60 Hz**

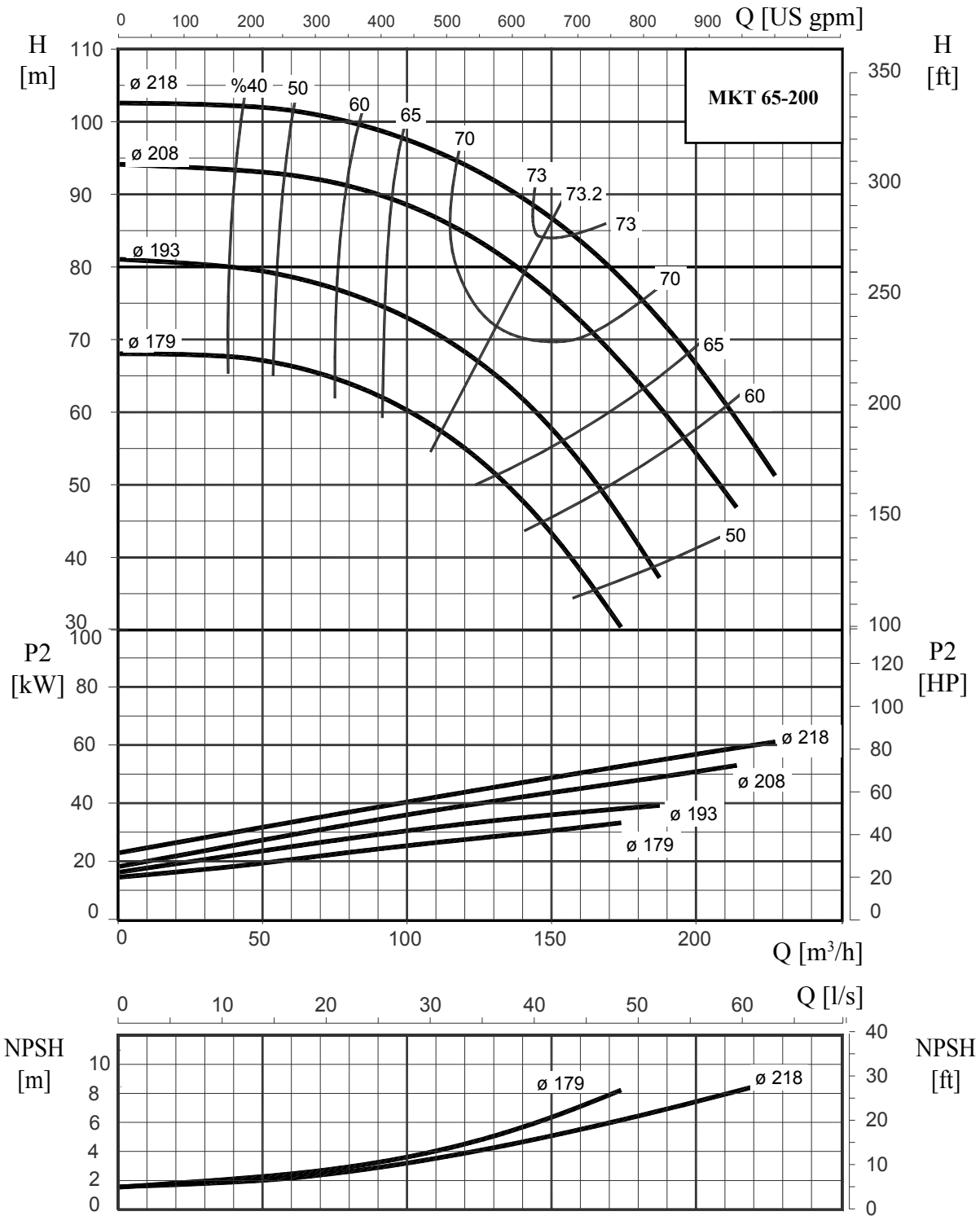

**Αποδόσεις σε/ Performance at 1750 r.p.m. 60 Hz**

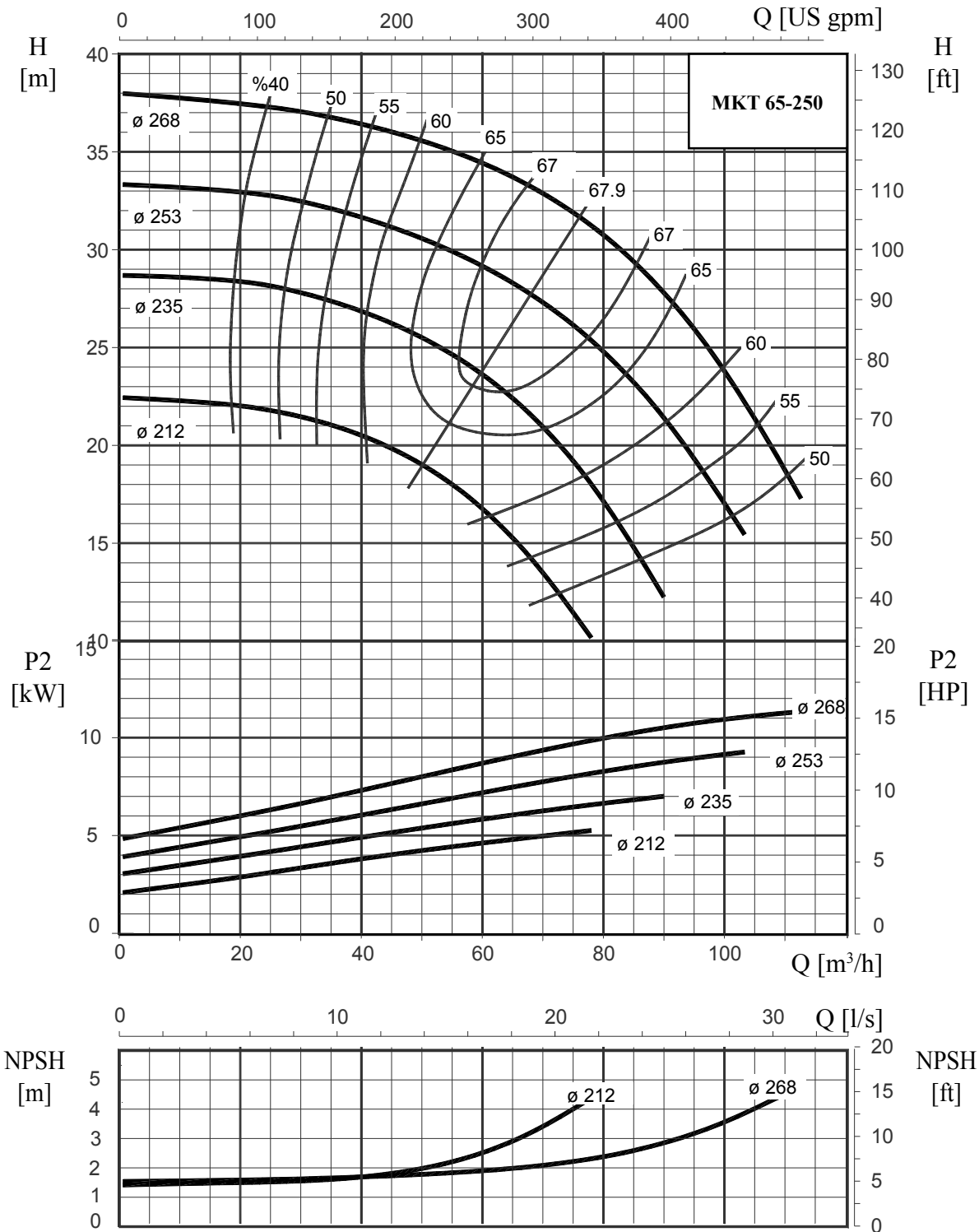

**Αποδόσεις σε/ Performance at 3500 r.p.m. 60 Hz**

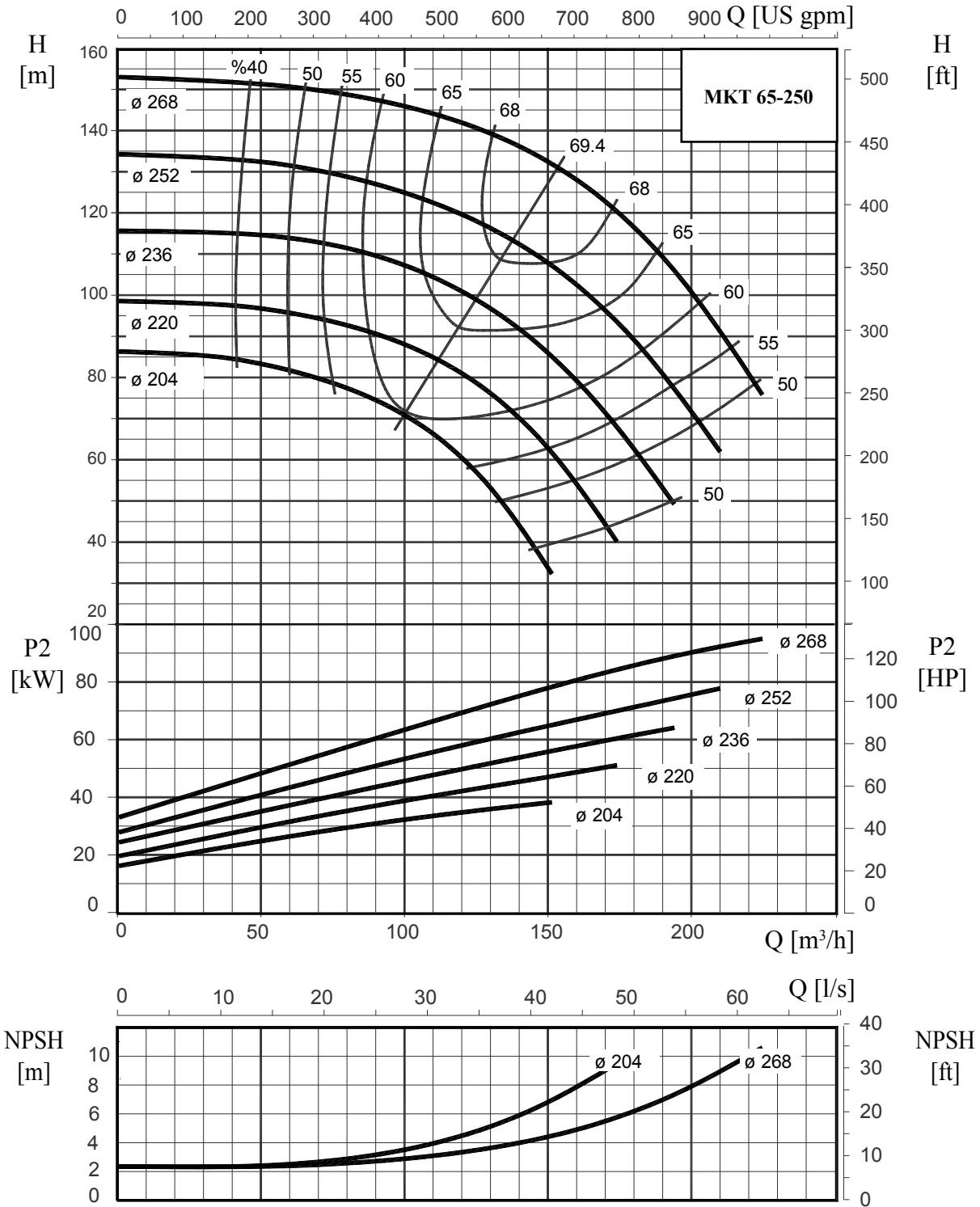

**Αποδόσεις σε/ Performance at 1750 r.p.m. 60 Hz**

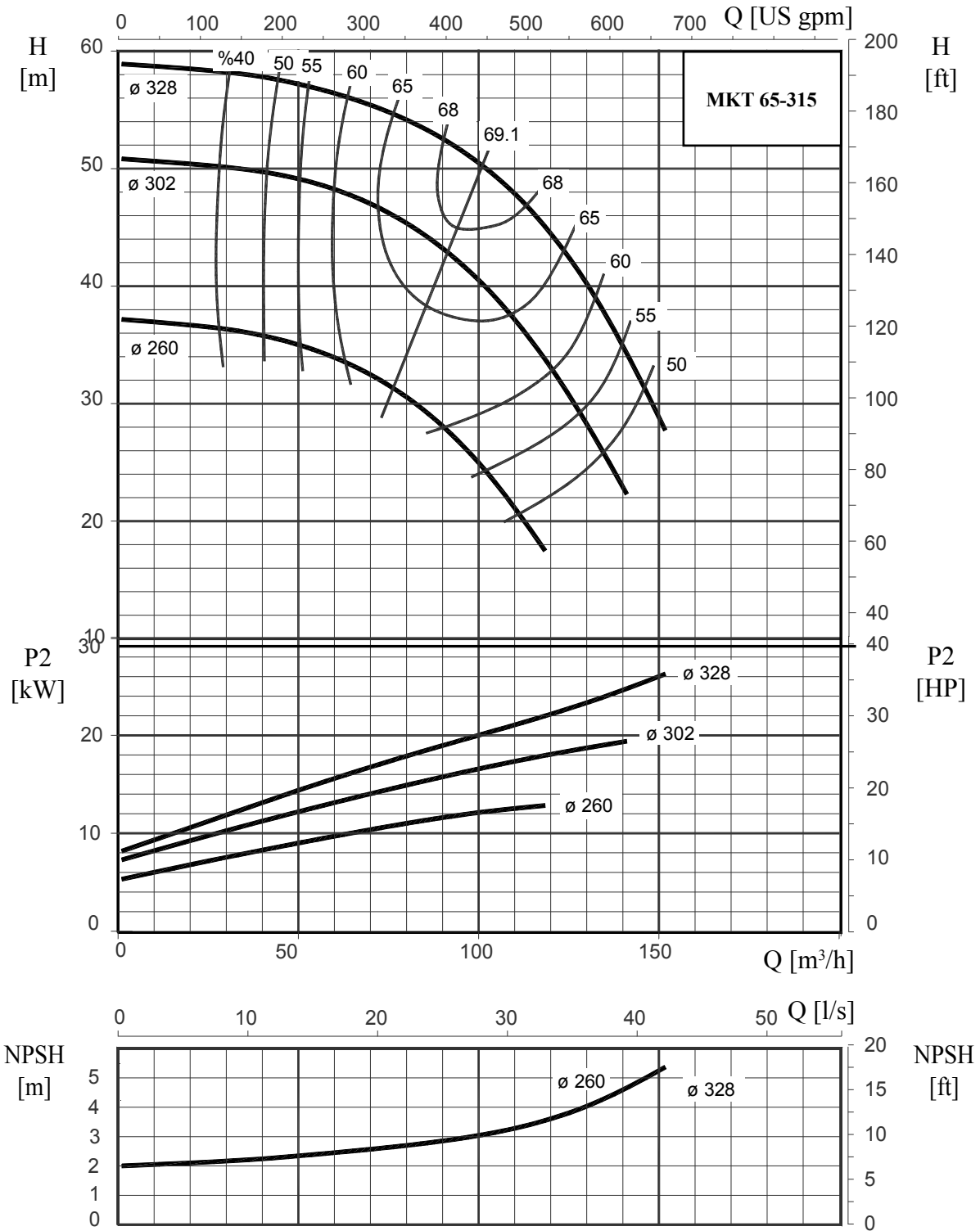

**Αποδόσεις σε/ Performance at 1750 r.p.m. 60 Hz**

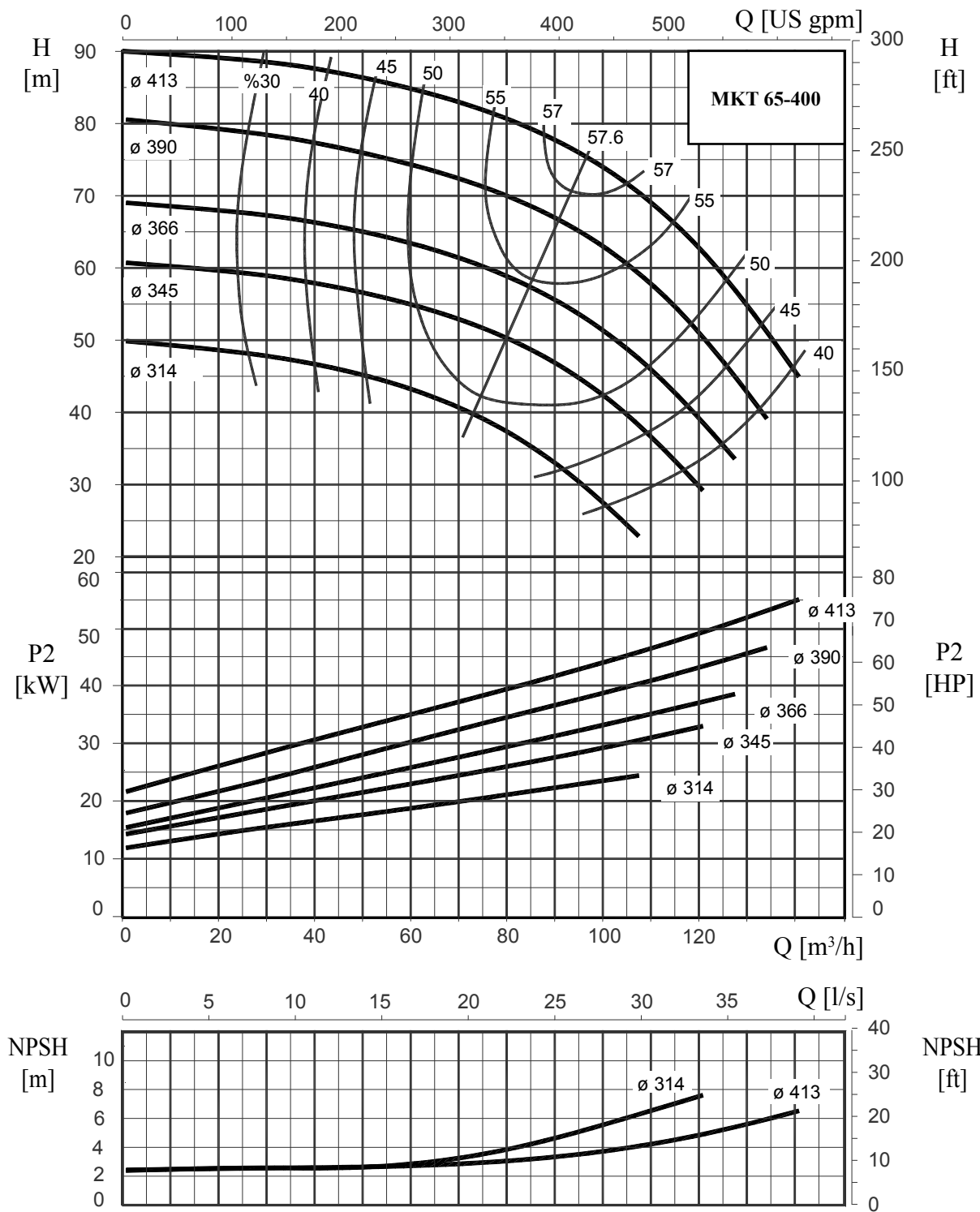



**Αποδόσεις σε/ Performance at 1750 r.p.m. 60 Hz**

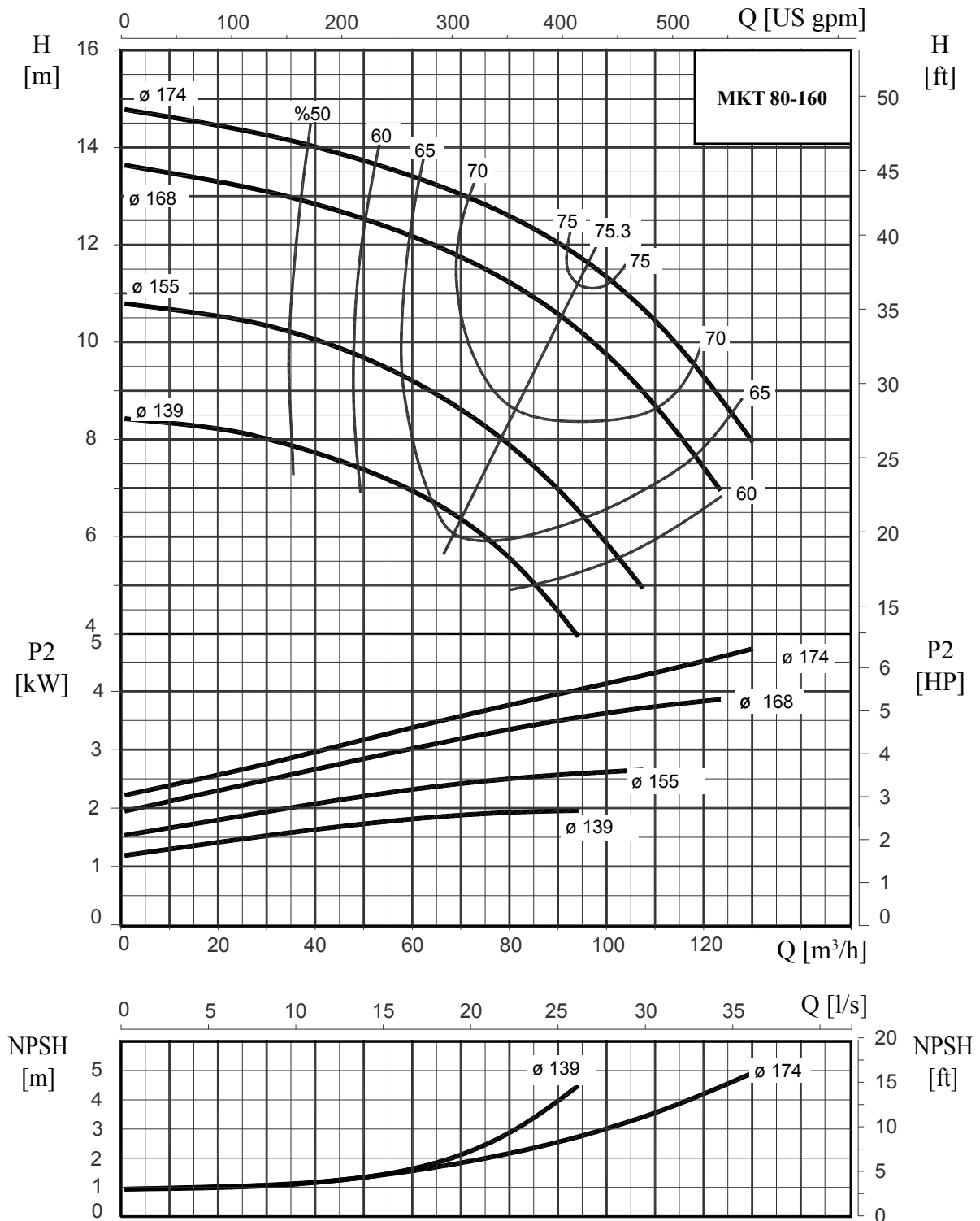

**Αποδόσεις σε/ Performance at 3500 r.p.m. 60 Hz**

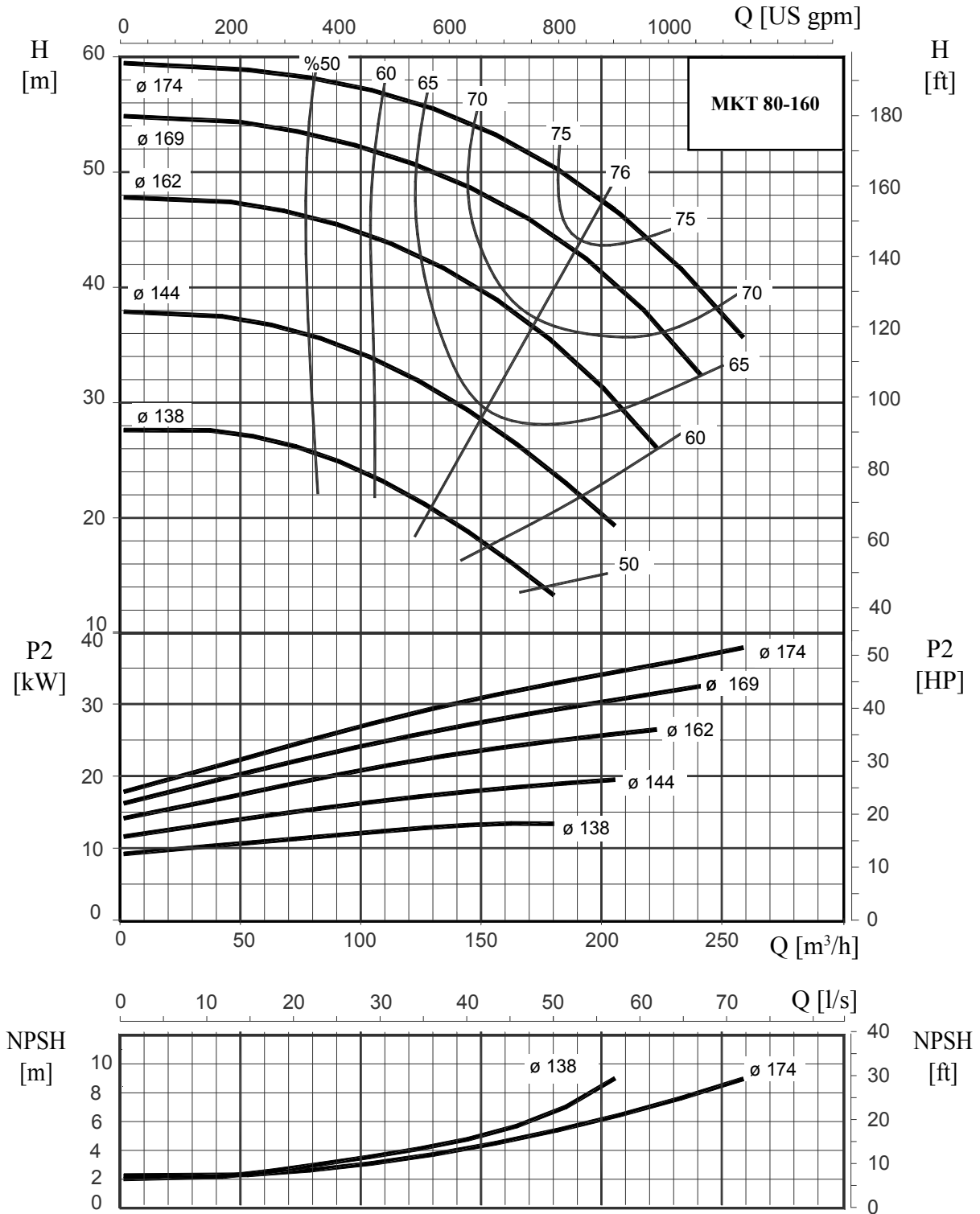

**Αποδόσεις σε/ Performance at 1750 r.p.m. 60 Hz**

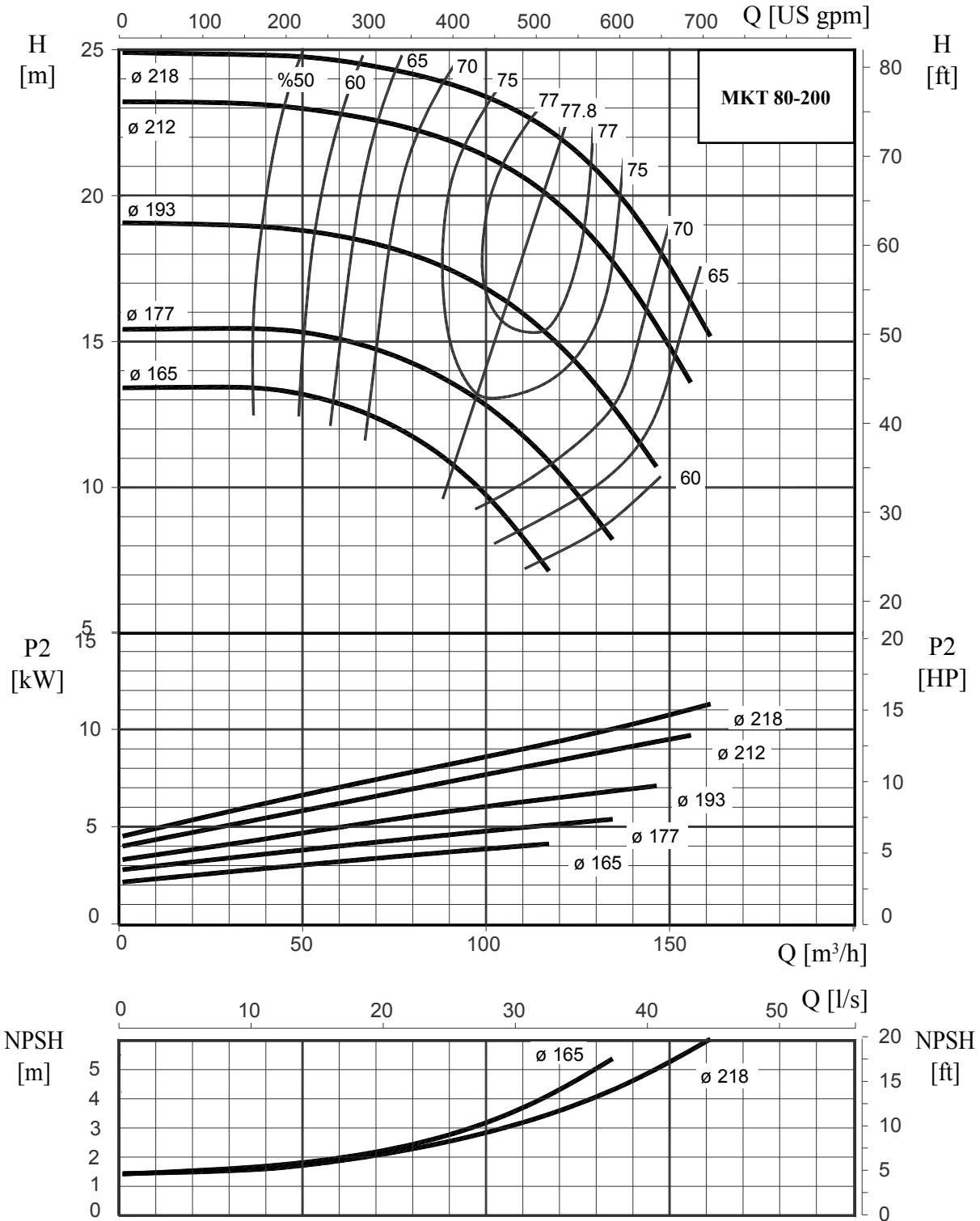

**Αποδόσεις σε/ Performance at 3500 r.p.m. 60 Hz**

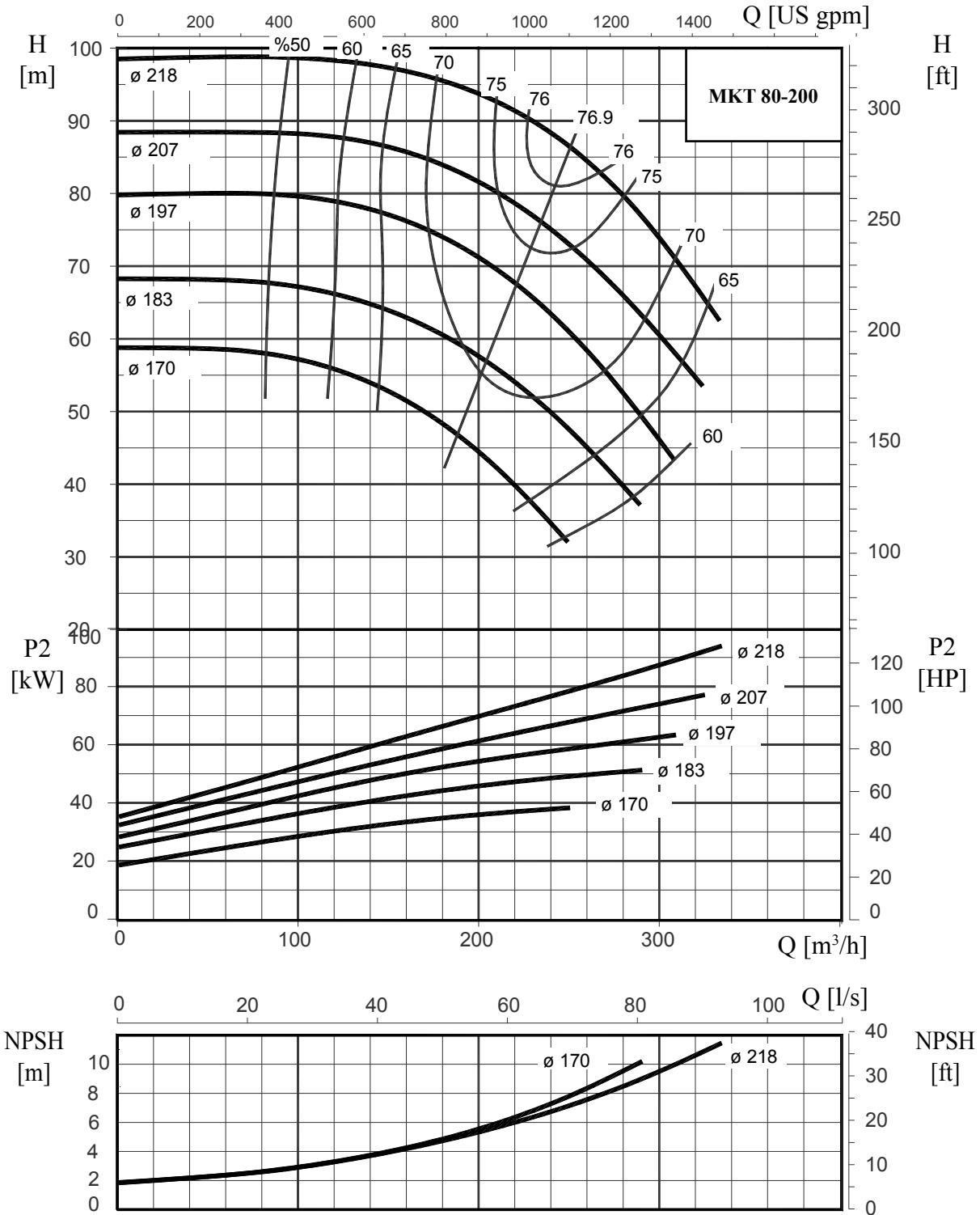

**Αποδόσεις σε/ Performance at 1750 r.p.m. 60 Hz**

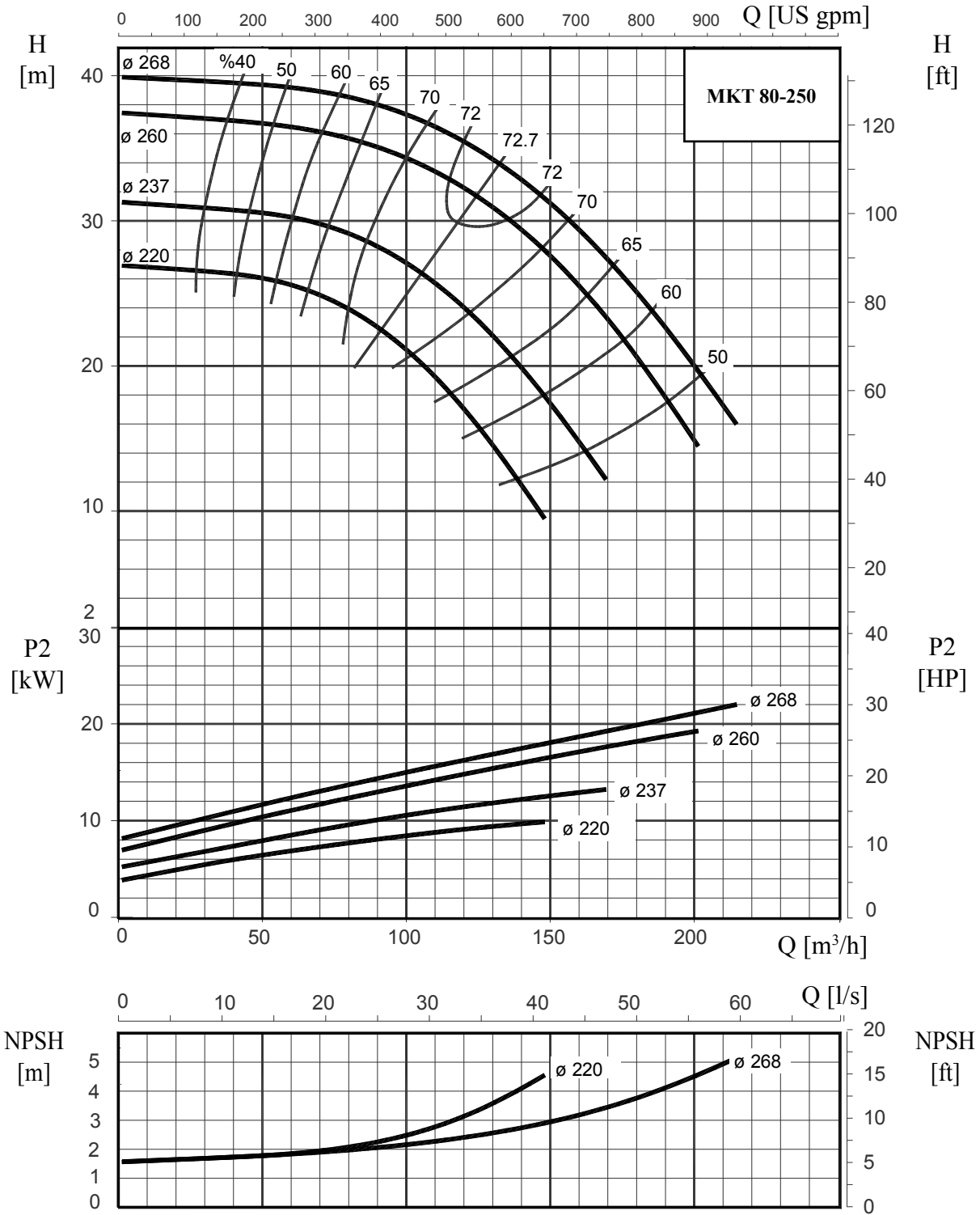

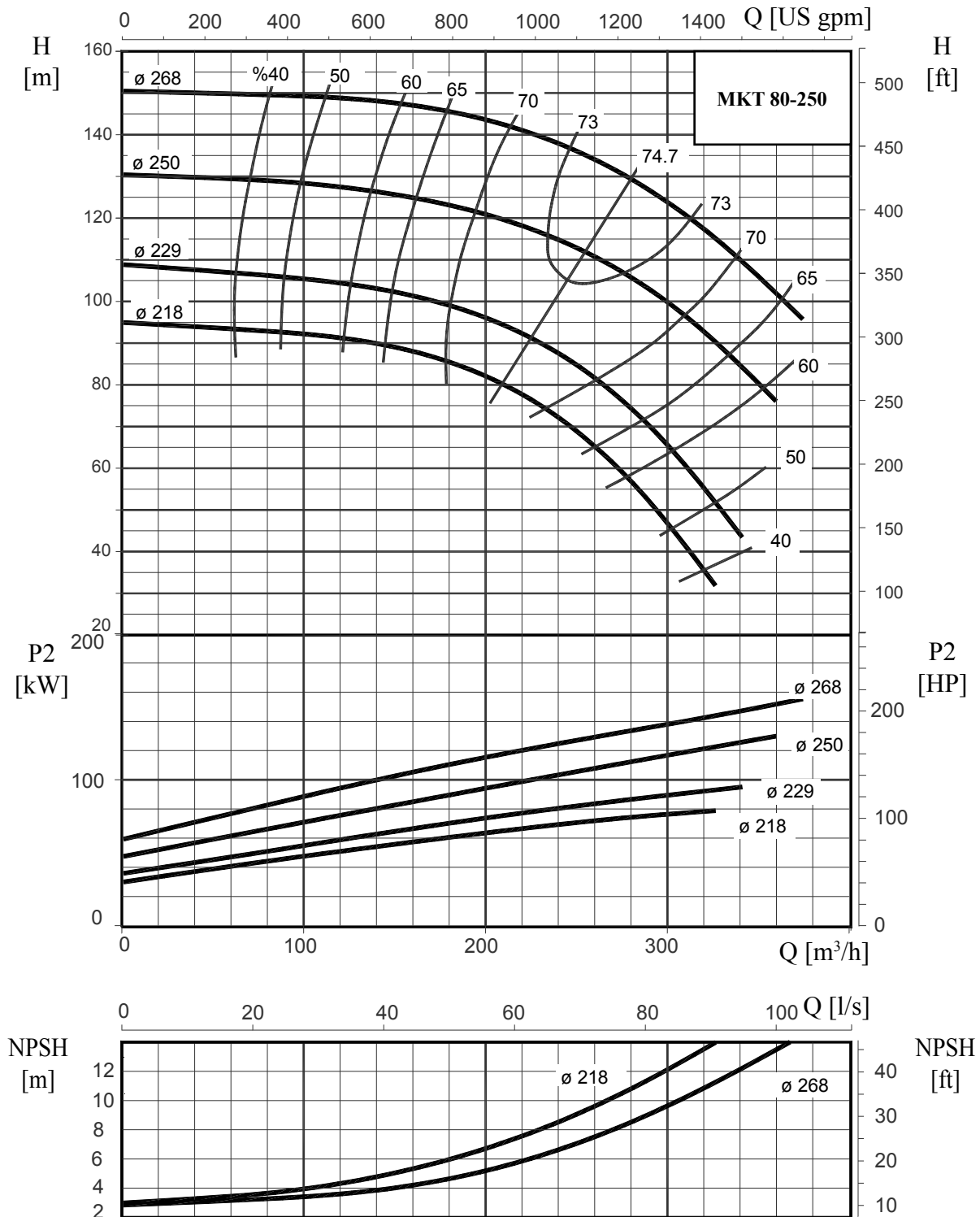
**Αποδόσεις σε/ Performance at 3500 r.p.m. 60 Hz**

**Αποδόσεις σε/ Performance at 1750 r.p.m. 60 Hz**

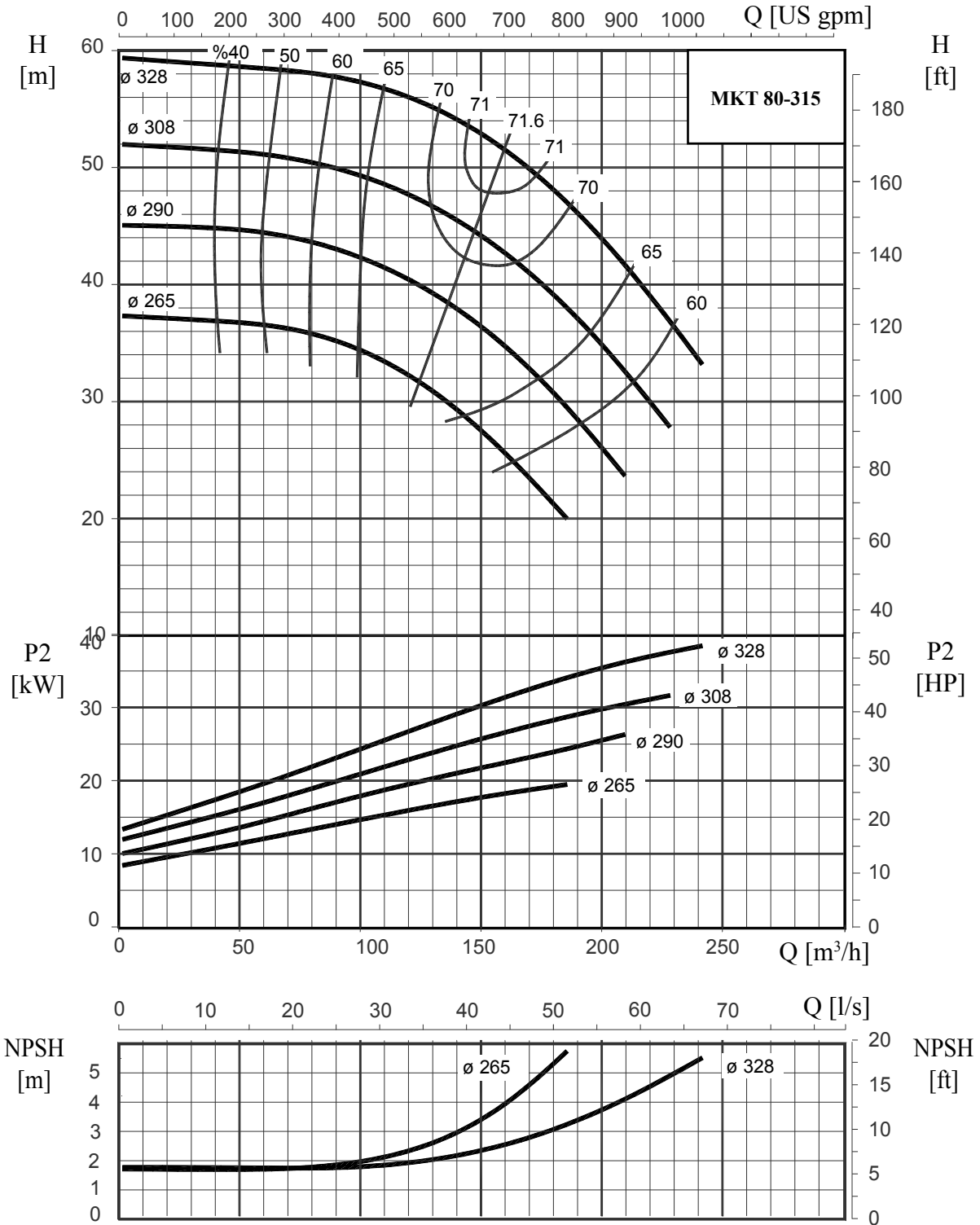

**Αποδόσεις σε/ Performance at 1750 r.p.m. 60 Hz**

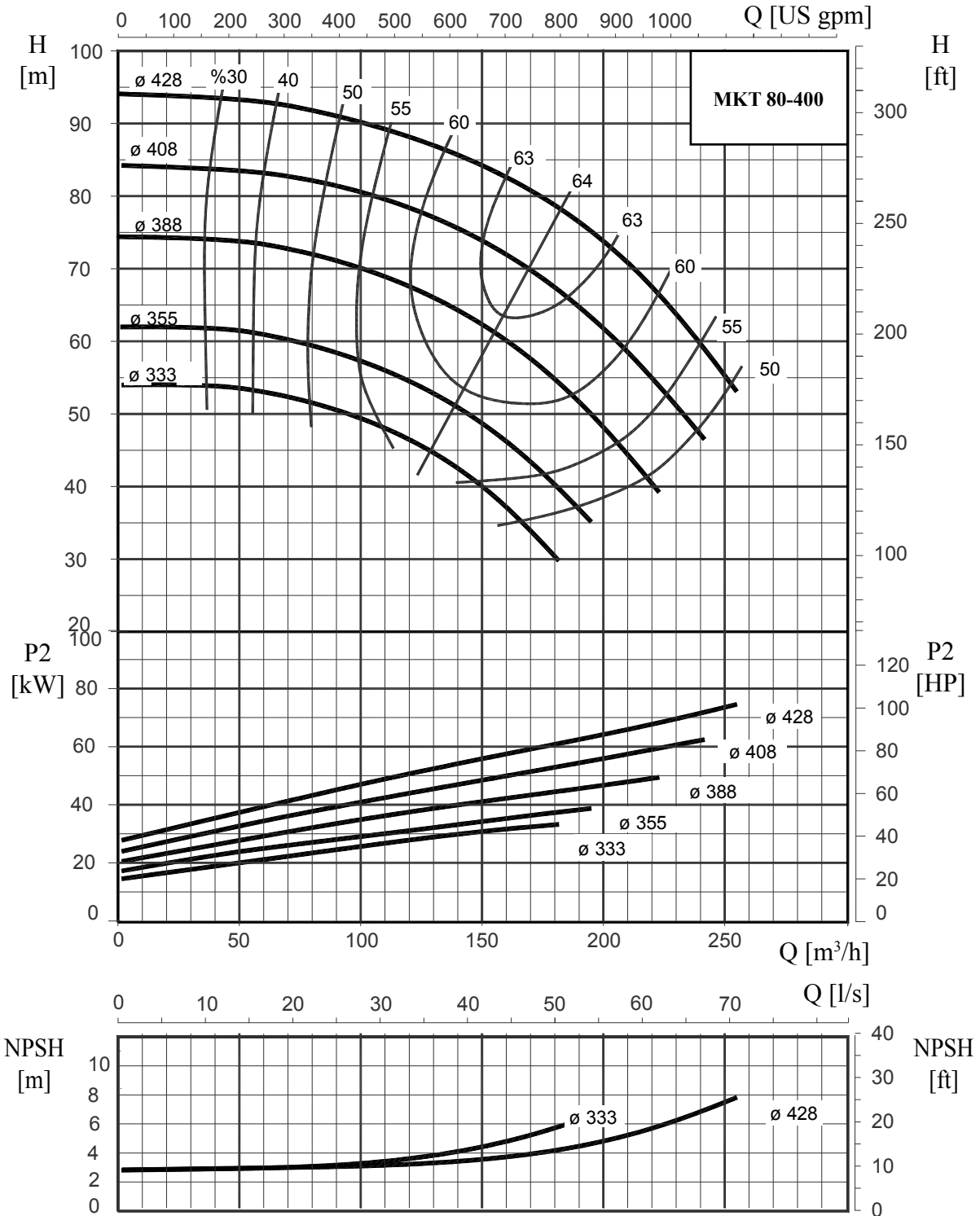



**Αποδόσεις σε/ Performance at 1750 r.p.m. 60 Hz**

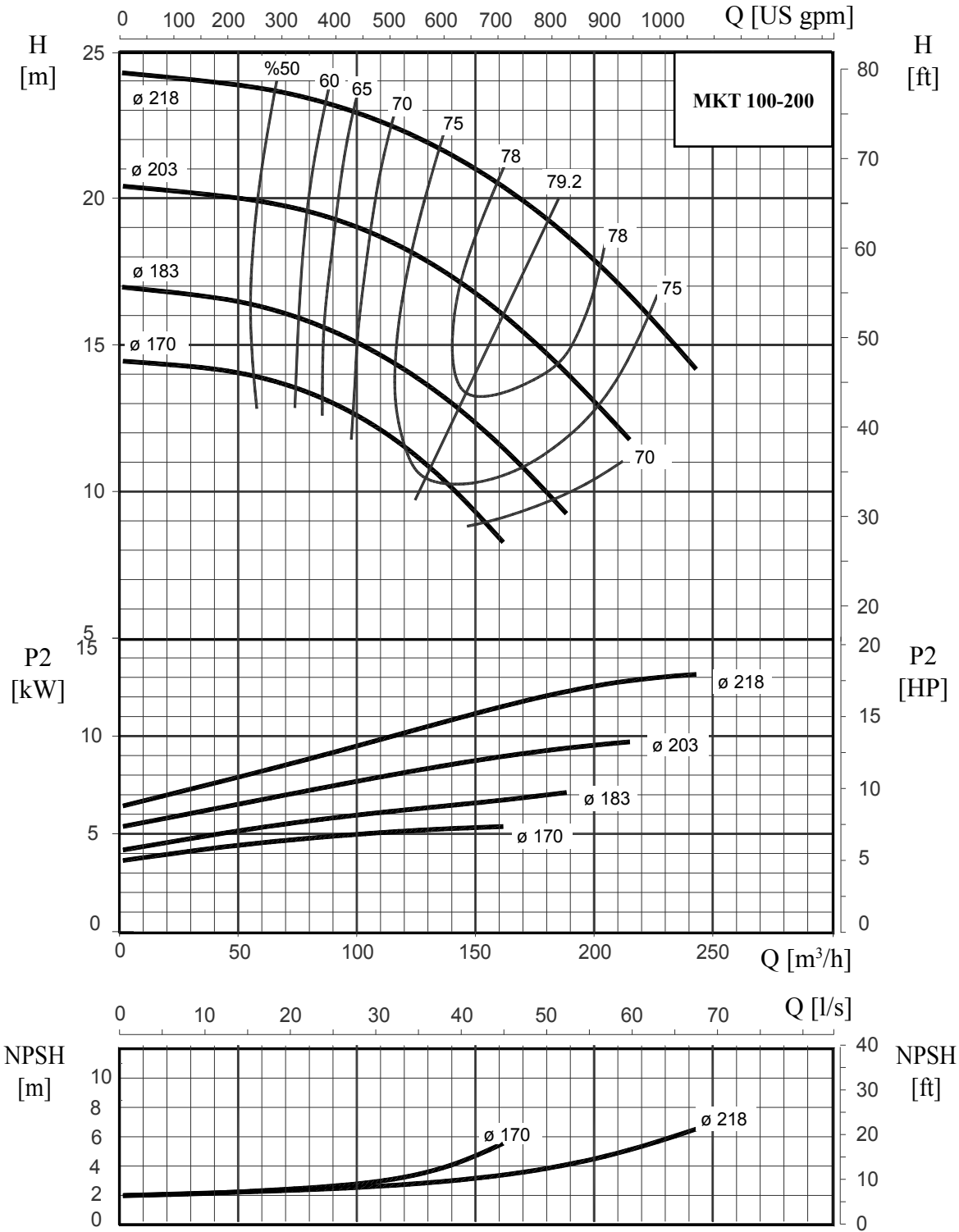

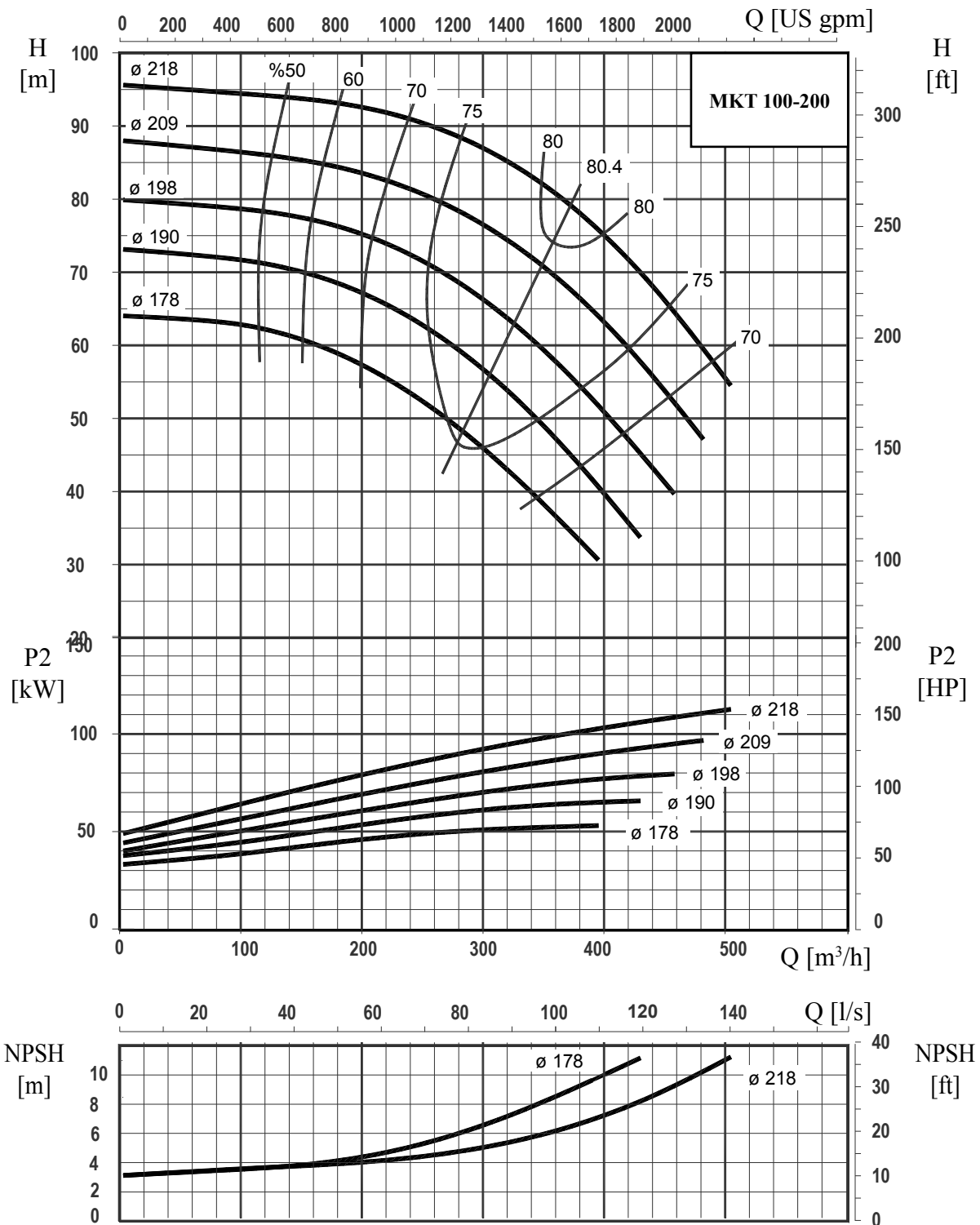
**Αποδόσεις σε/ Performance at 3500 r.p.m. 60 Hz**

**Αποδόσεις σε/ Performance at 1750 r.p.m. 60 Hz**

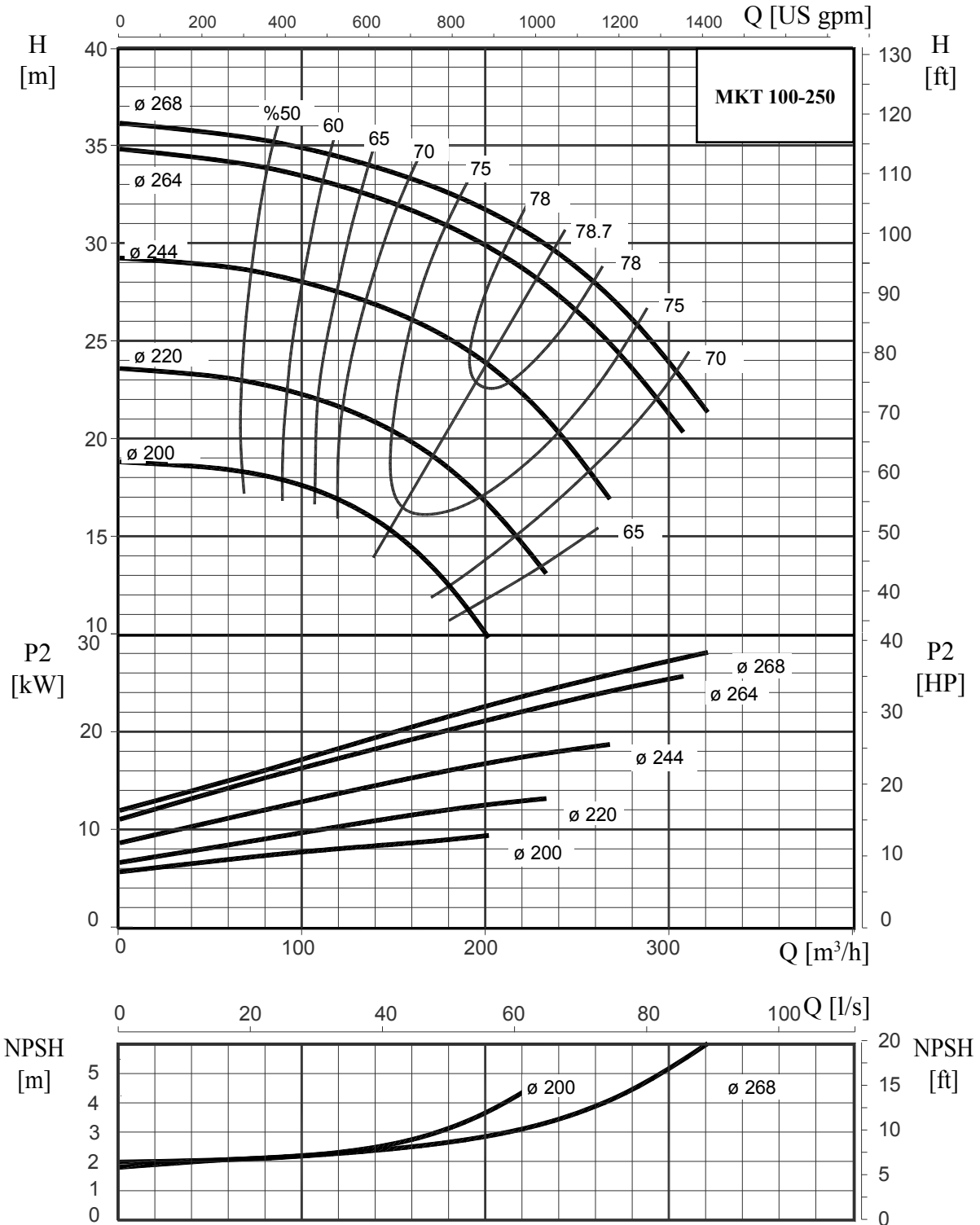

**Αποδόσεις σε/ Performance at 3500 r.p.m. 60 Hz**

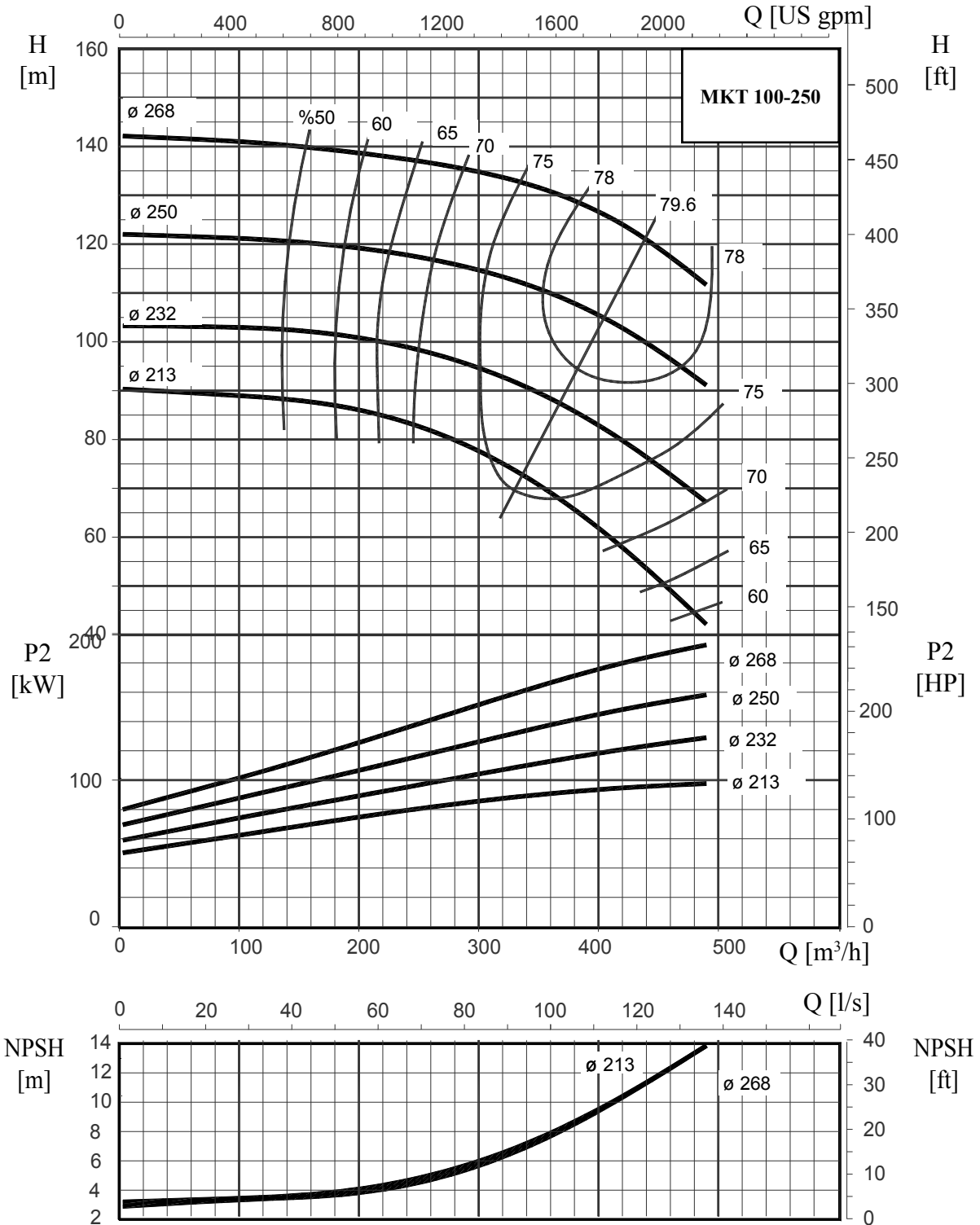

**Αποδόσεις σε/ Performance at 1750 r.p.m. 60 Hz**

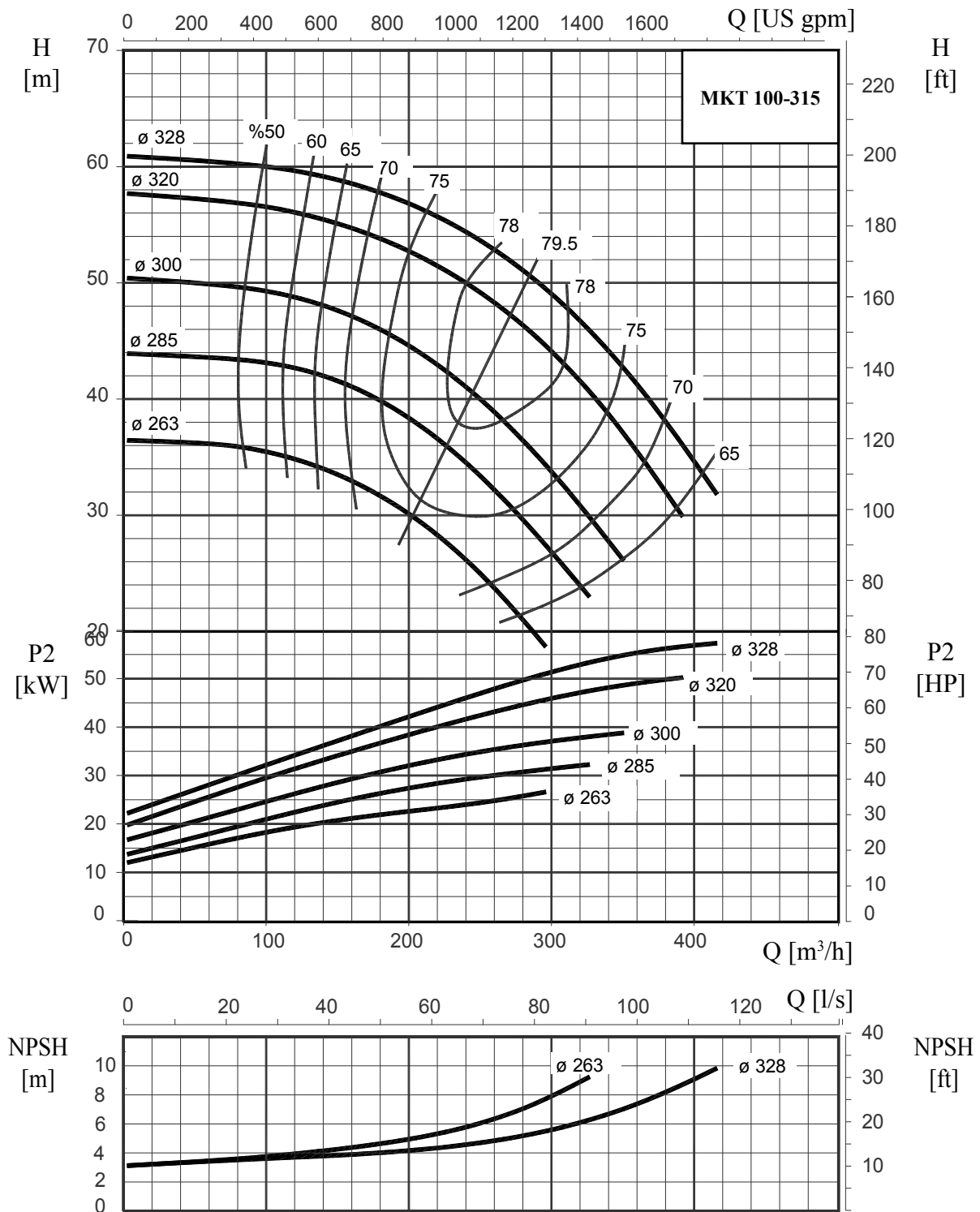

**Αποδόσεις σε/ Performance at 1750 r.p.m. 60 Hz**

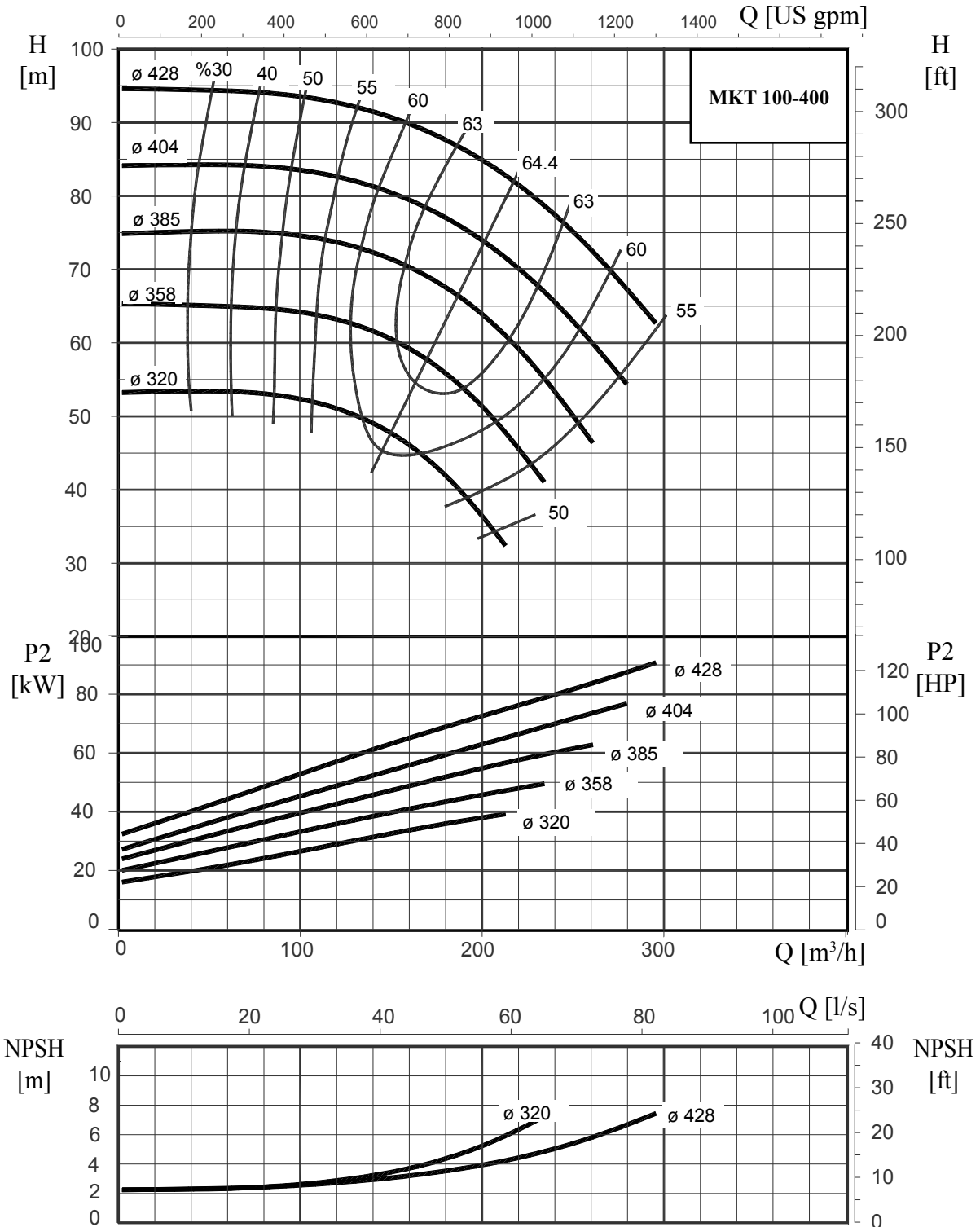

**Αποδόσεις σε/ Performance at 1750 r.p.m. 60 Hz**

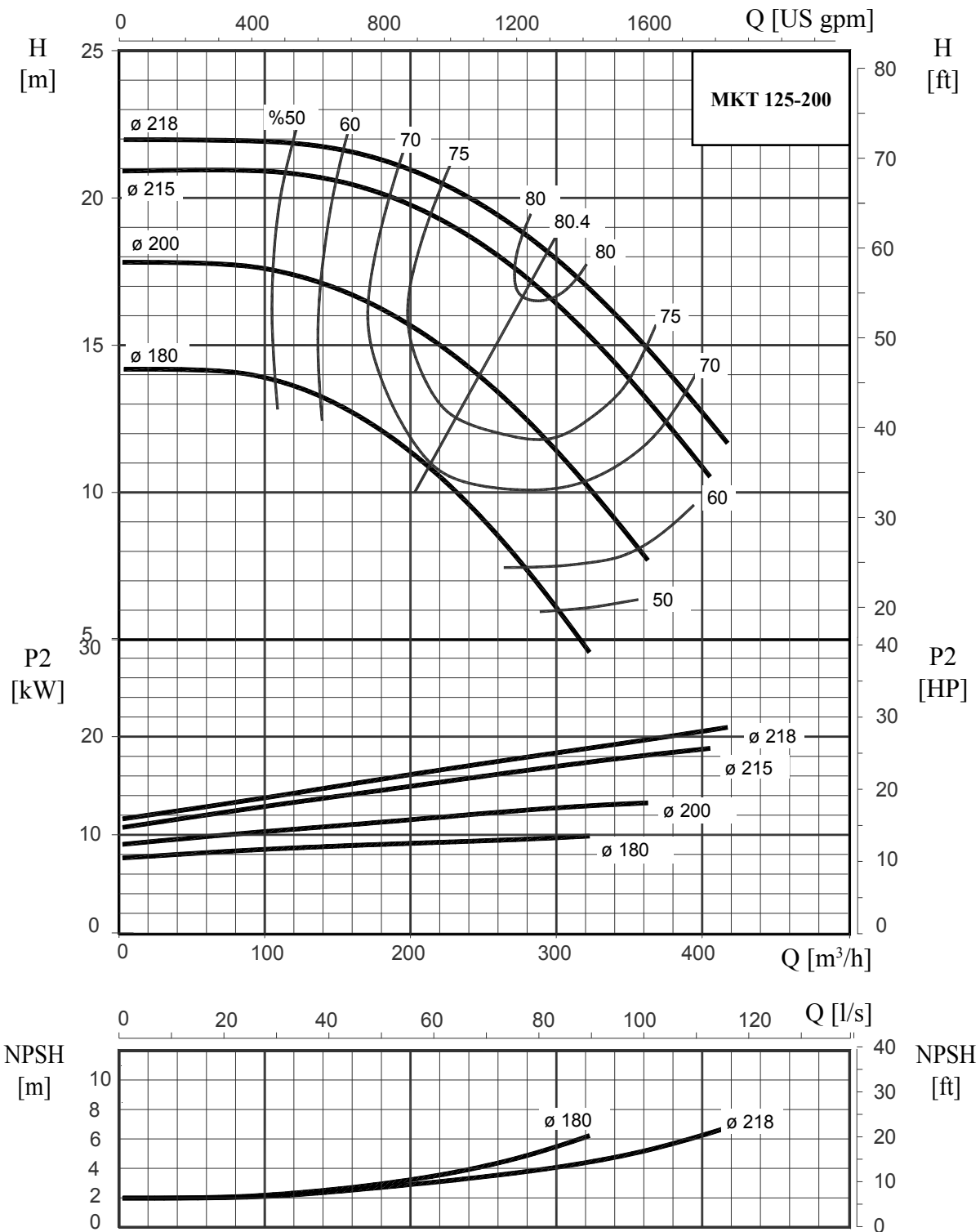

**Αποδόσεις σε/ Performance at 1750 r.p.m. 60 Hz**

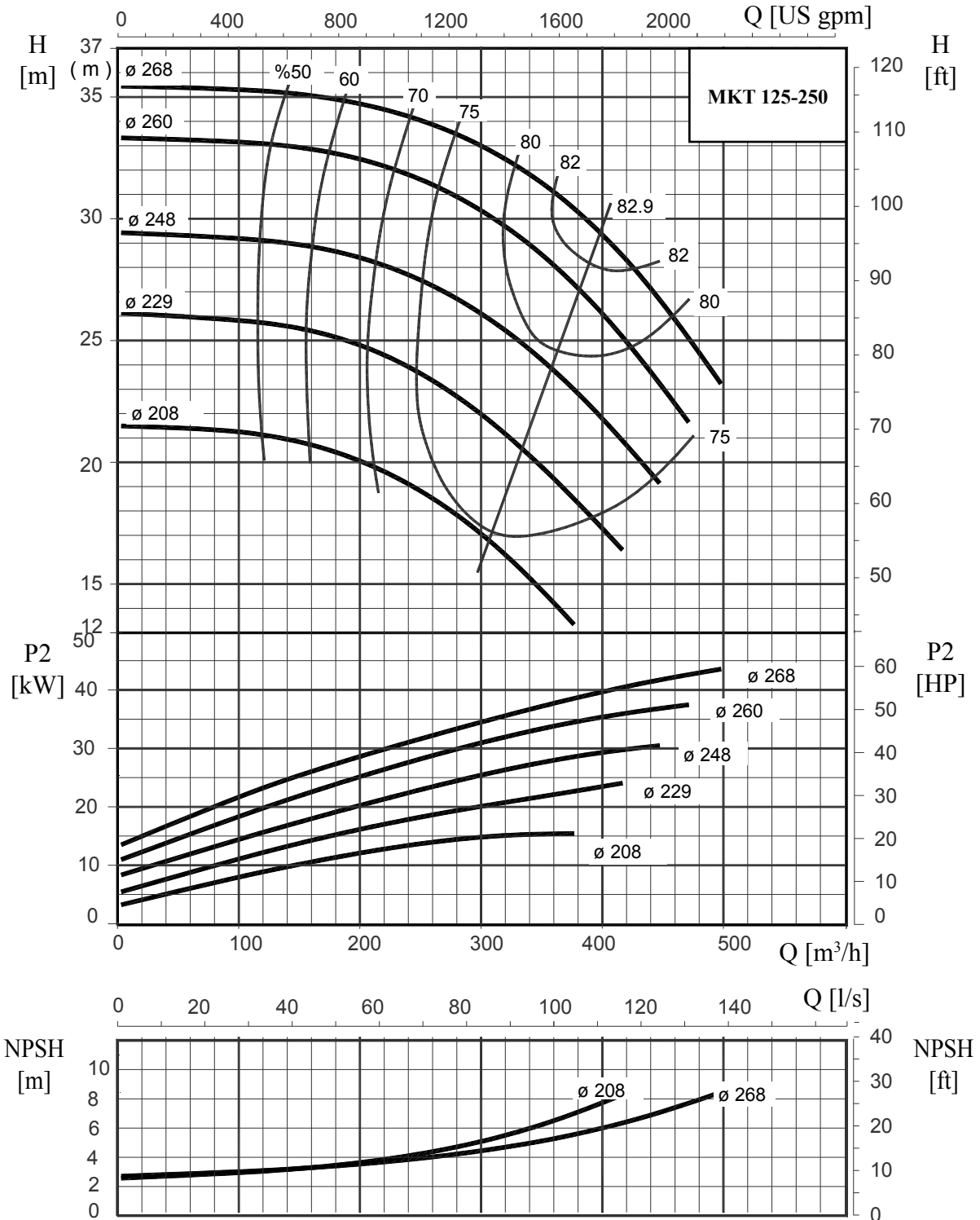



**Αποδόσεις σε/ Performance at 1750 r.p.m. 60 Hz**

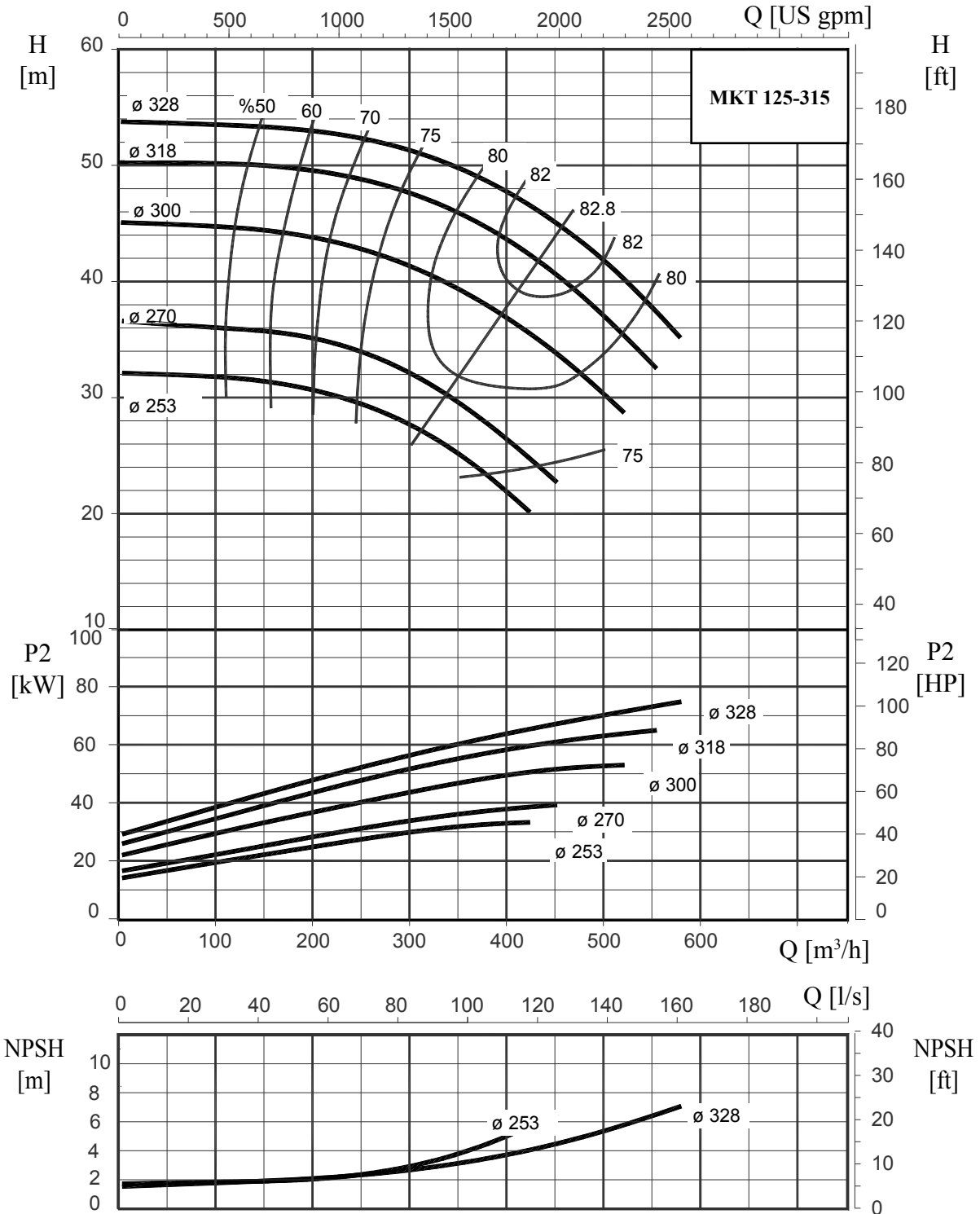

**Αποδόσεις σε/ Performance at 1750 r.p.m. 60 Hz**

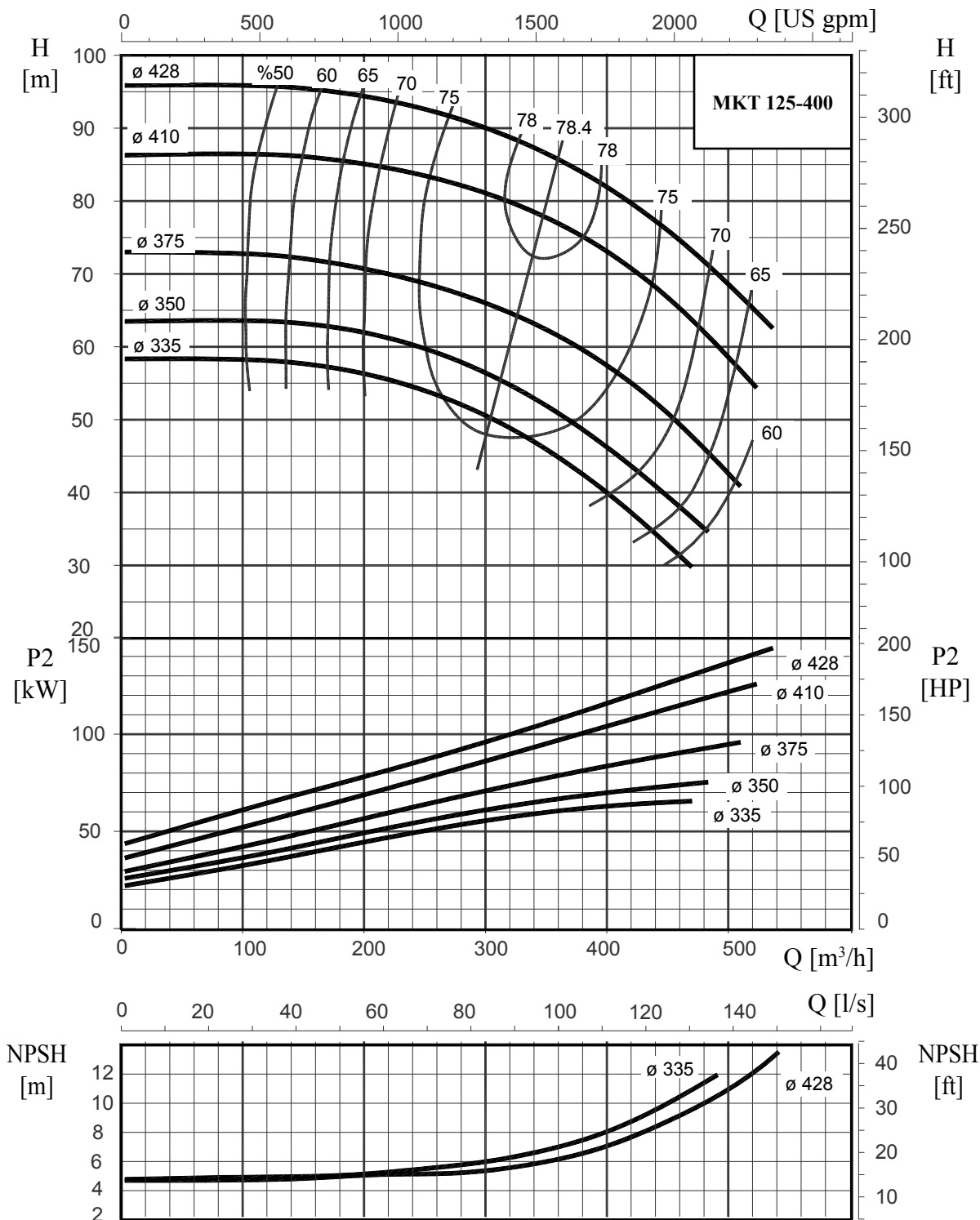

**Αποδόσεις σε/ Performance at 1750 r.p.m. 60 Hz**

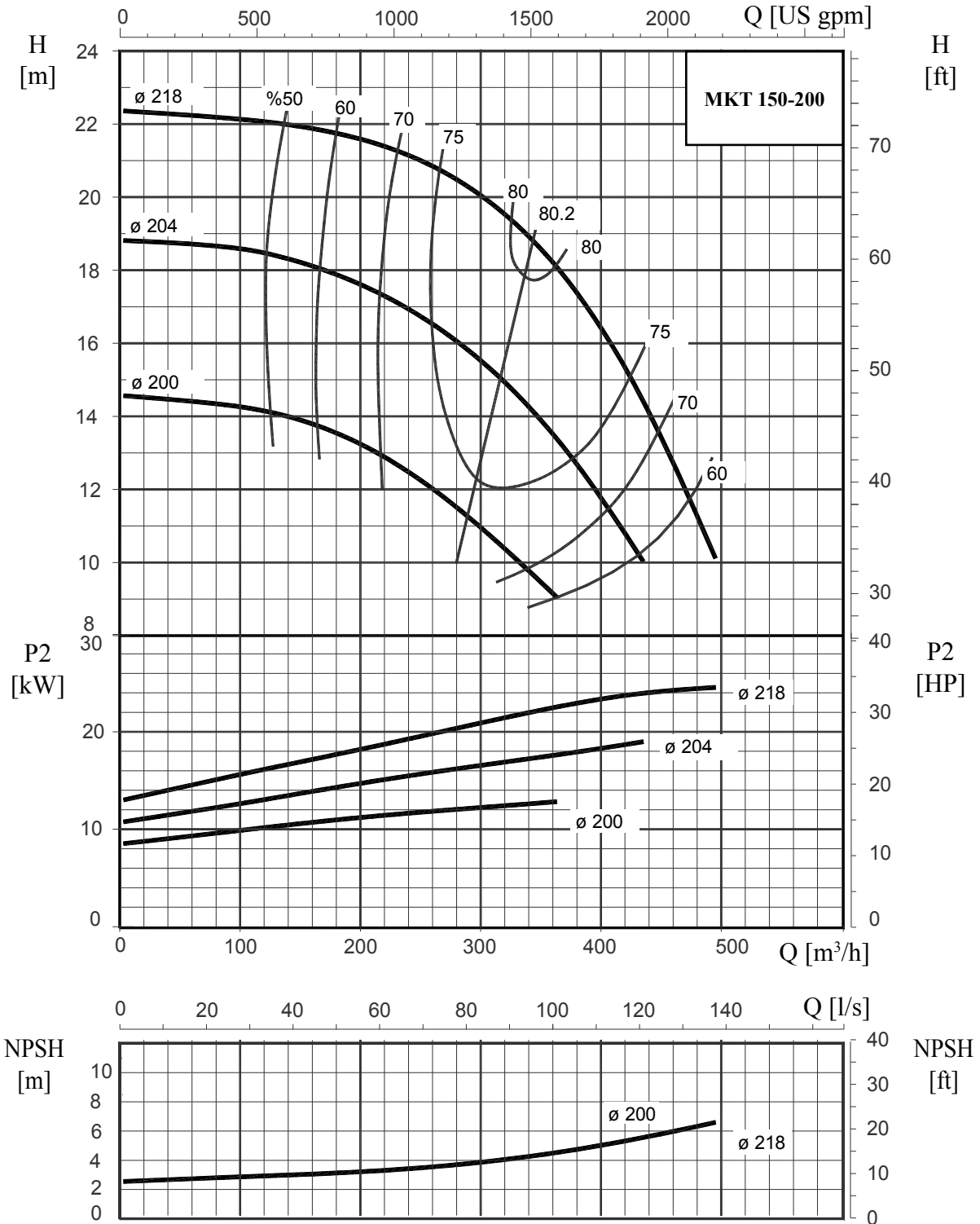

**Αποδόσεις σε/ Performance at 1750 r.p.m. 60 Hz**

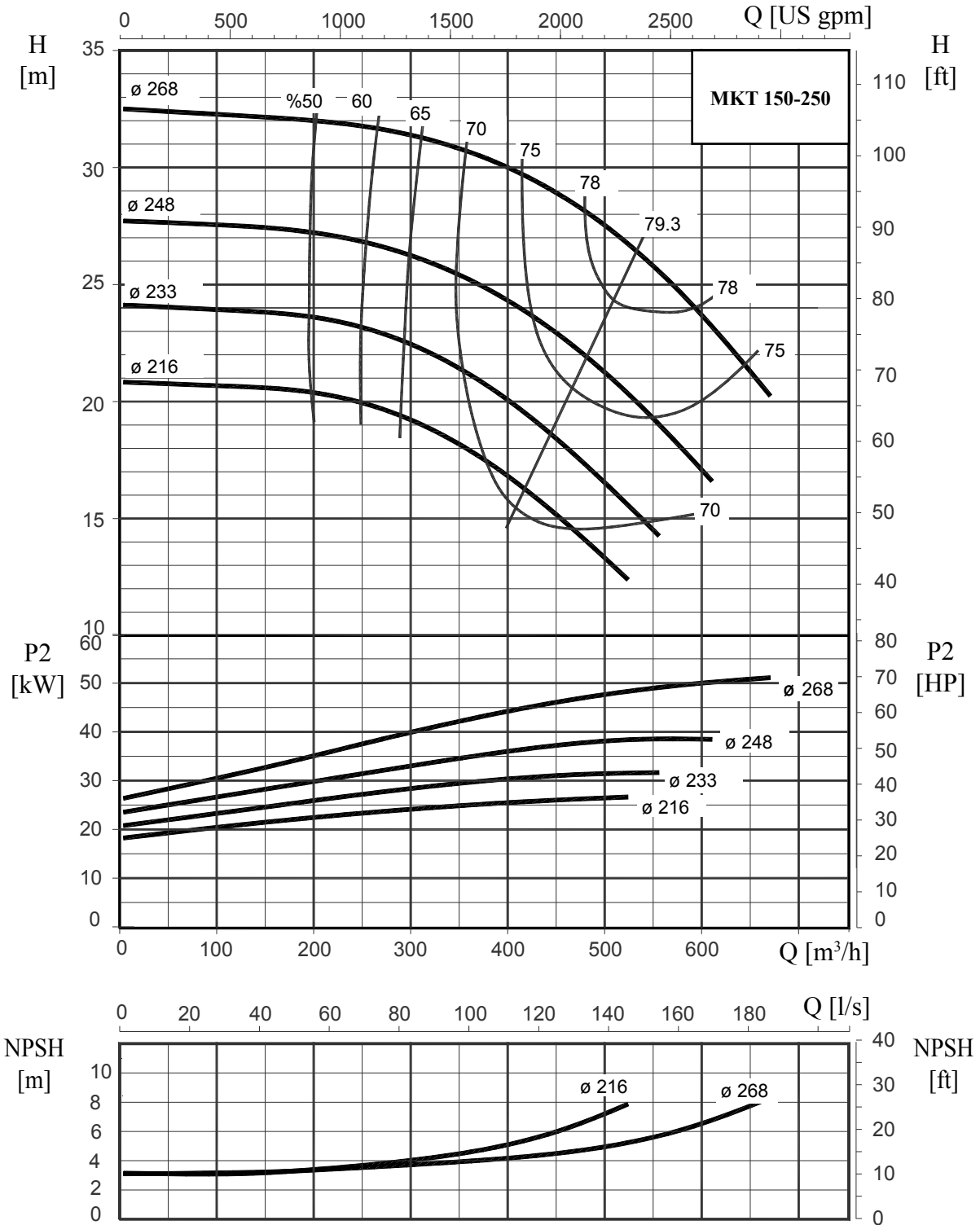

**Αποδόσεις σε/ Performance at 1750 r.p.m. 60 Hz**

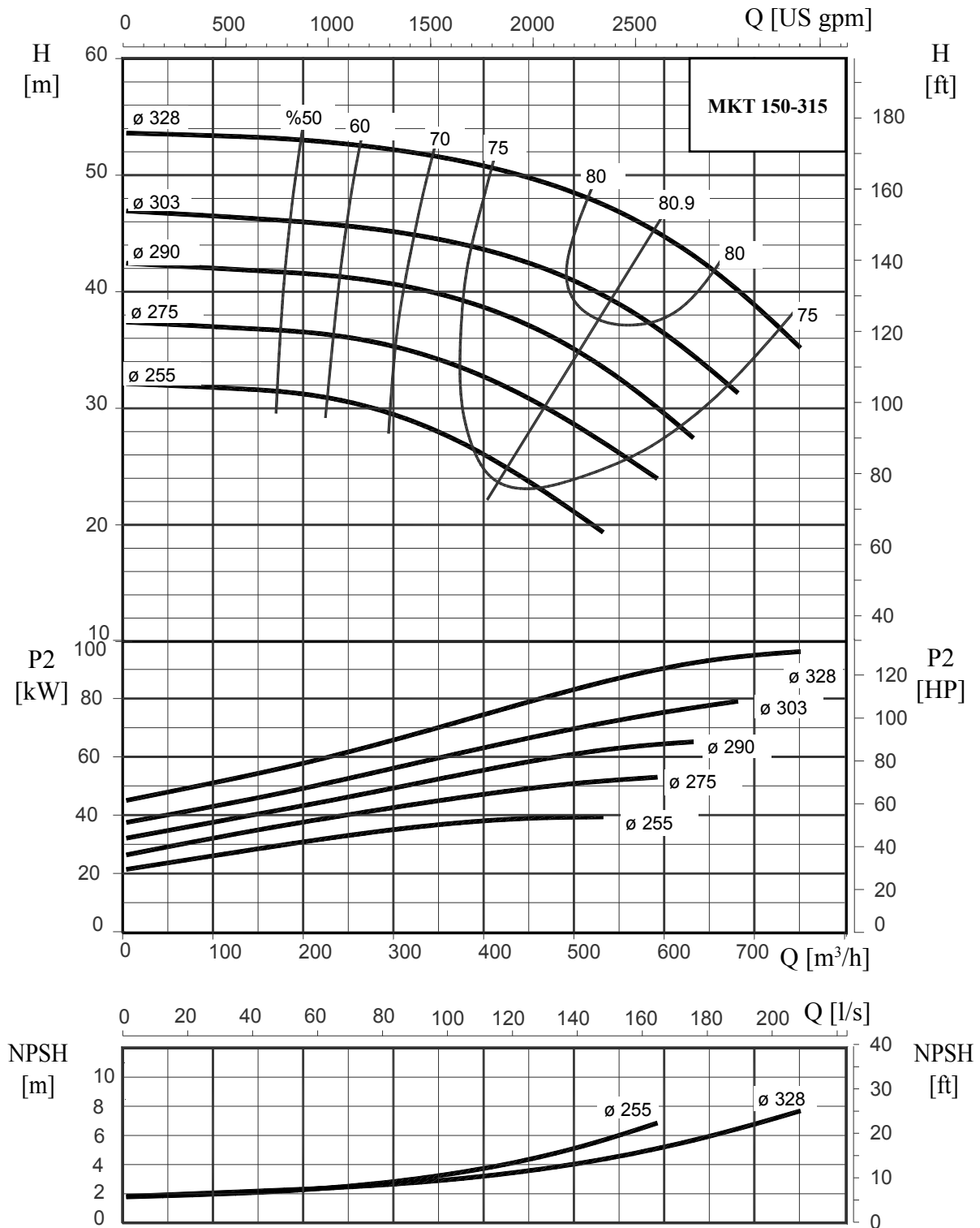

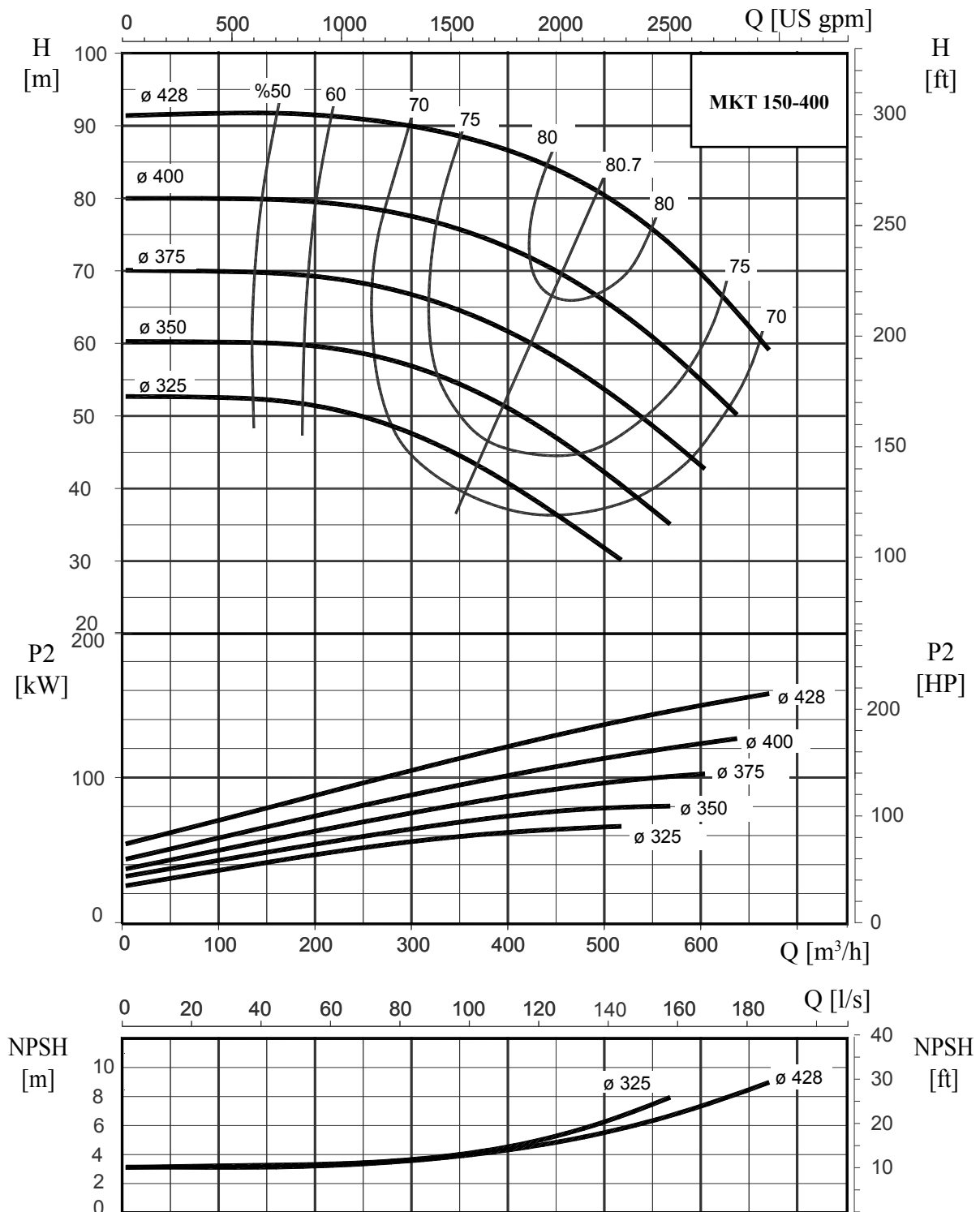
**Αποδόσεις σε/ Performance at 1750 r.p.m. 60 Hz**

**Αποδόσεις σε/ Performance at 1750 r.p.m. 60 Hz**

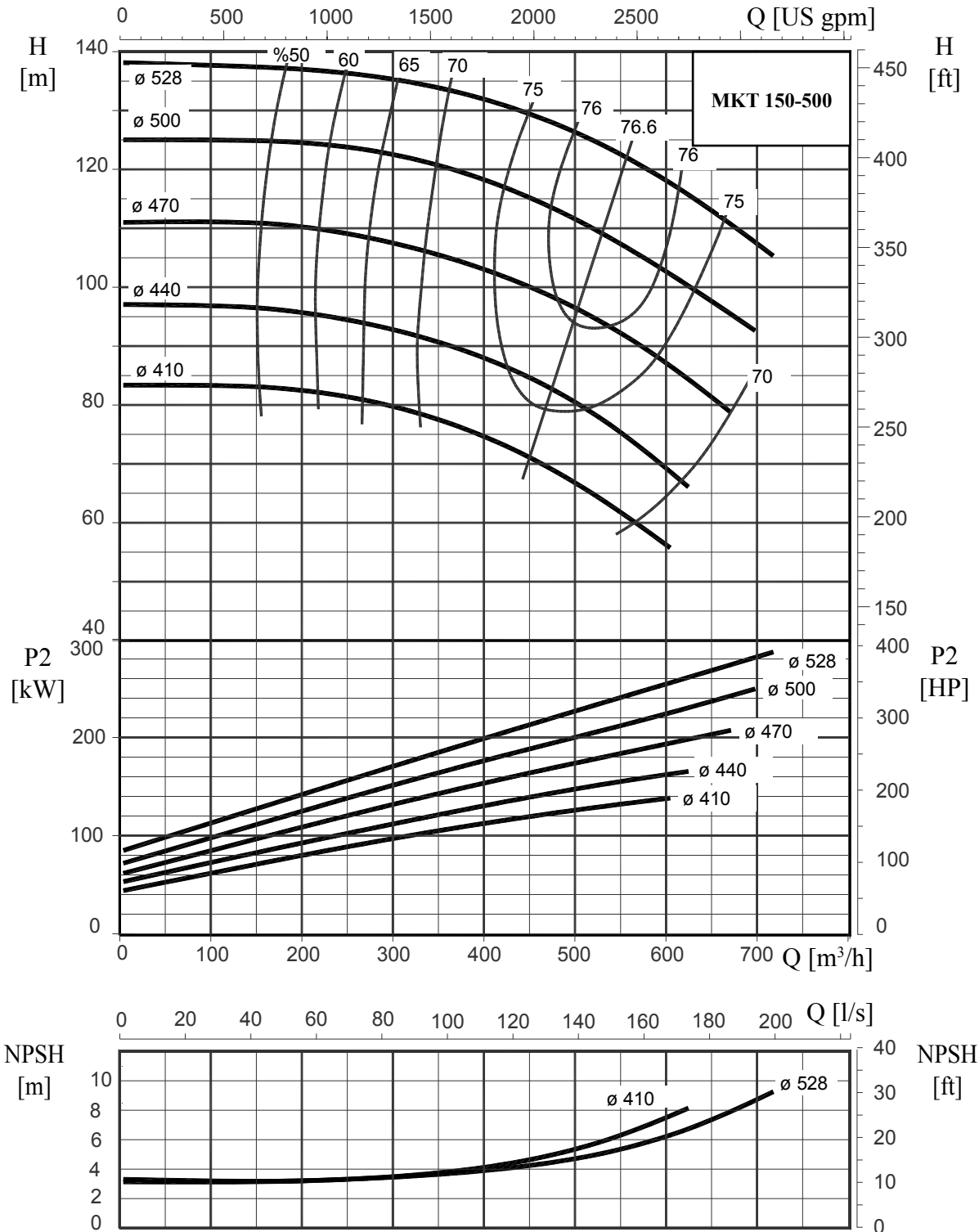

**Αποδόσεις σε/ Performance at 1750 r.p.m. 60 Hz**

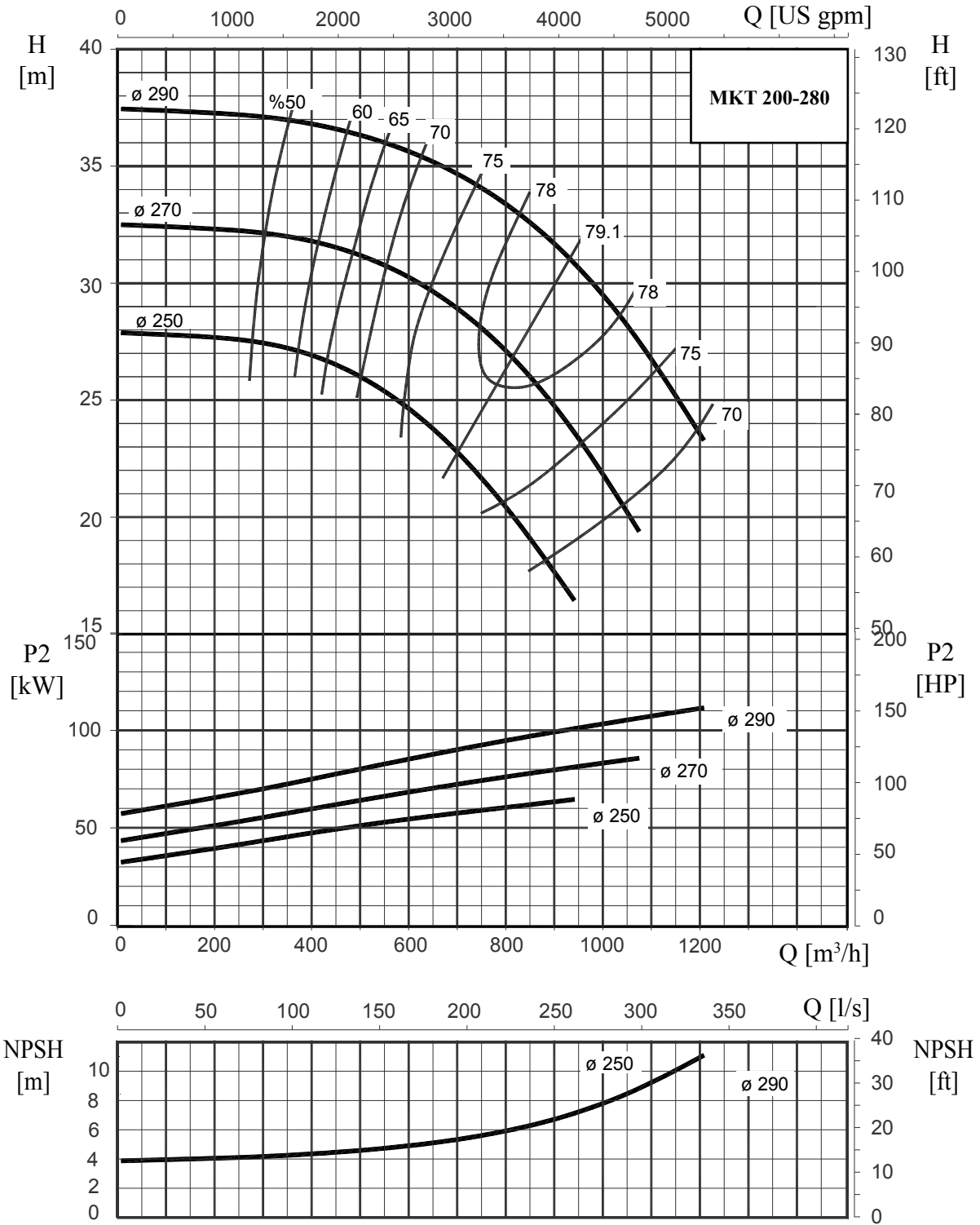



**Αποδόσεις σε/ Performance at 1750 r.p.m. 60 Hz**

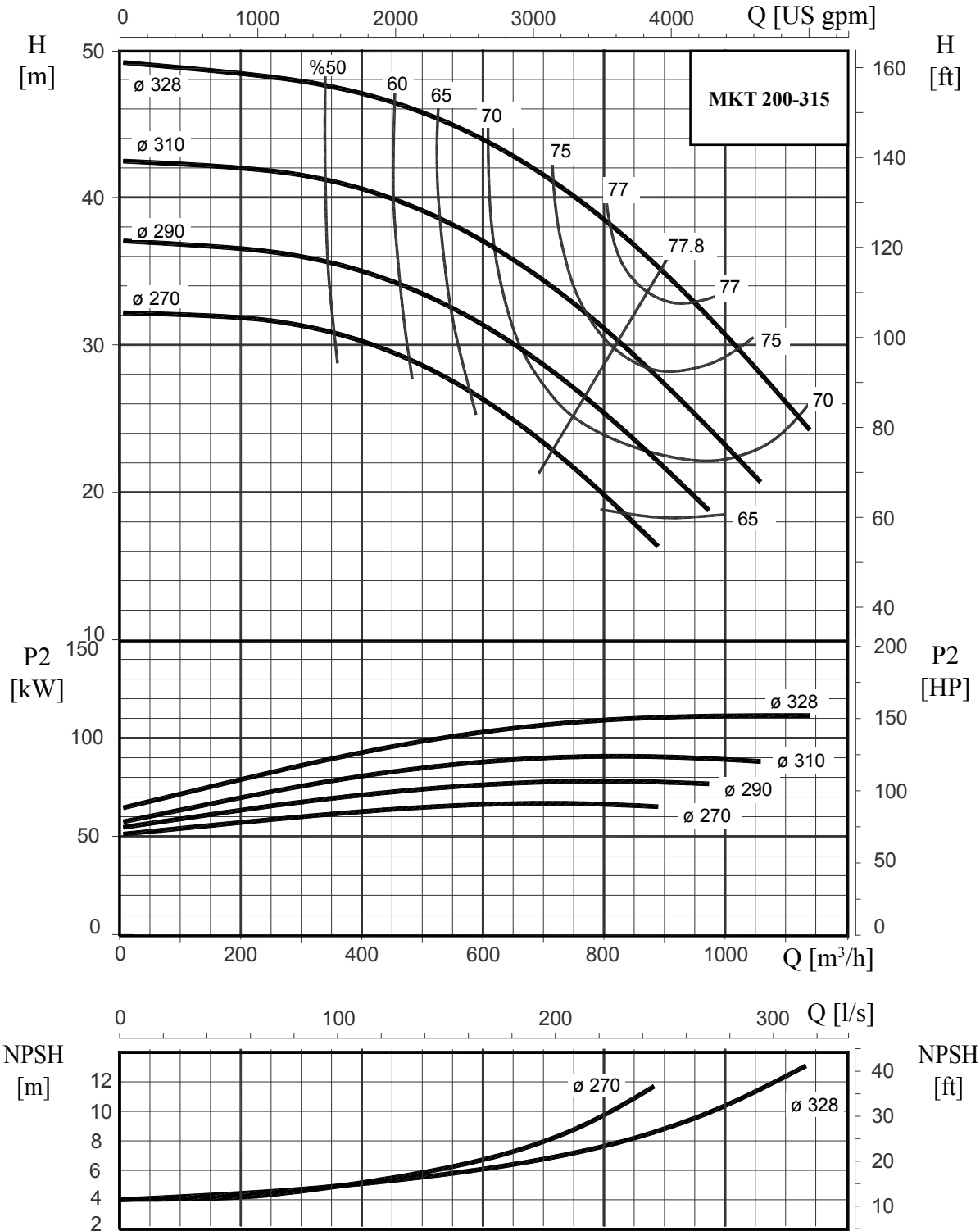

**Αποδόσεις σε/ Performance at 1750 r.p.m. 60 Hz**

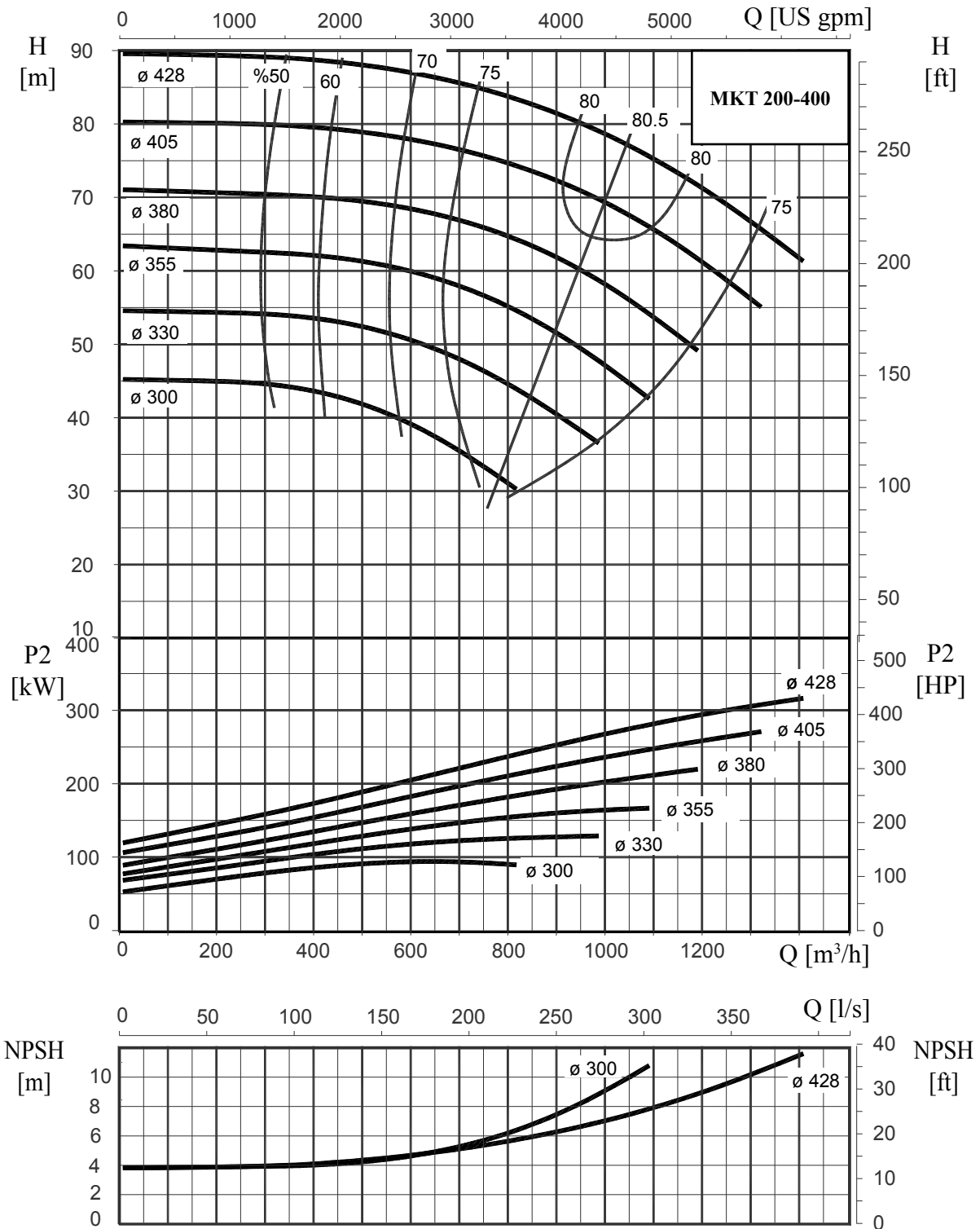

**Αποδόσεις σε/ Performance at 1750 r.p.m. 60 Hz**

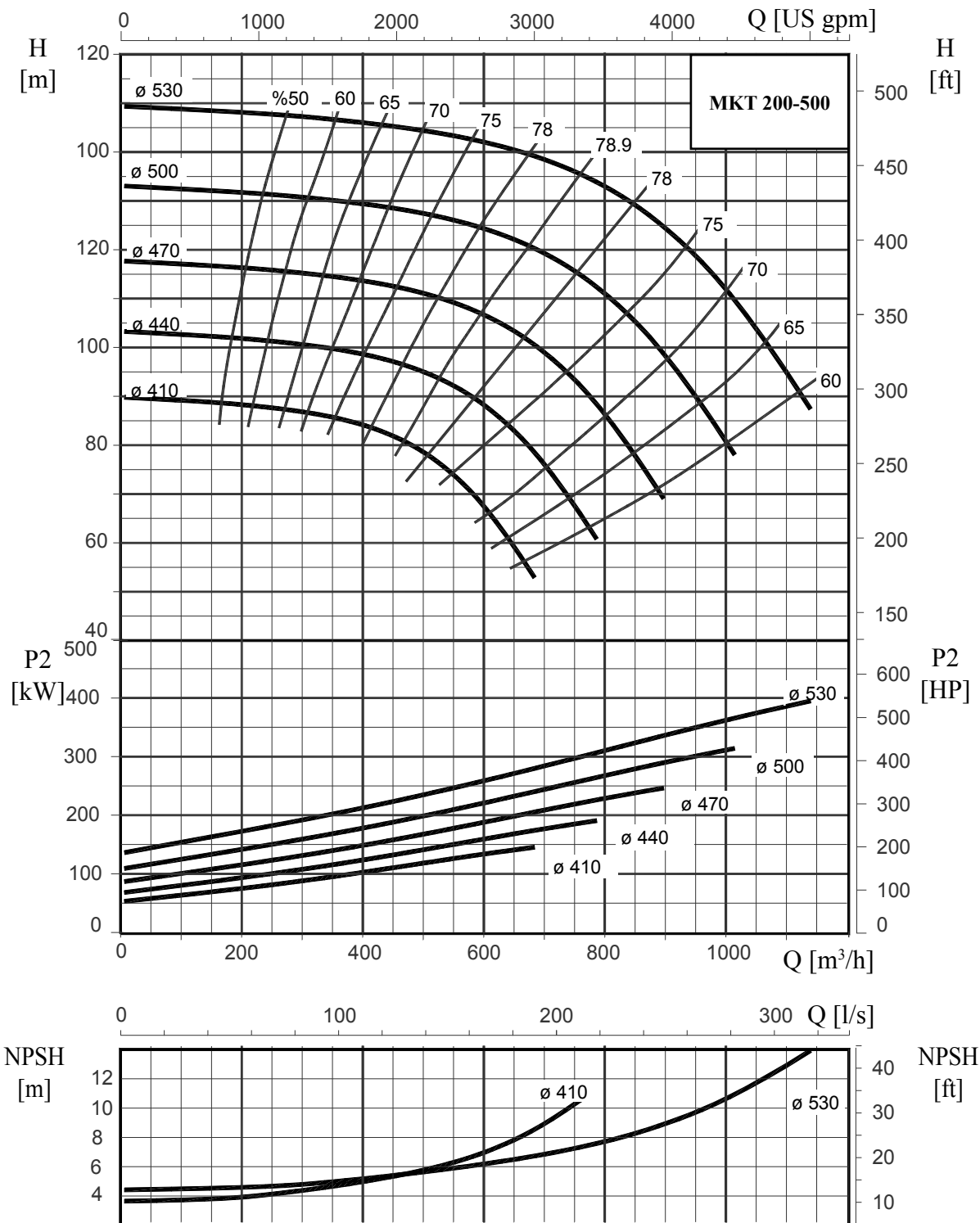

**Αποδόσεις σε/ Performance at 1750 r.p.m. 60 Hz**

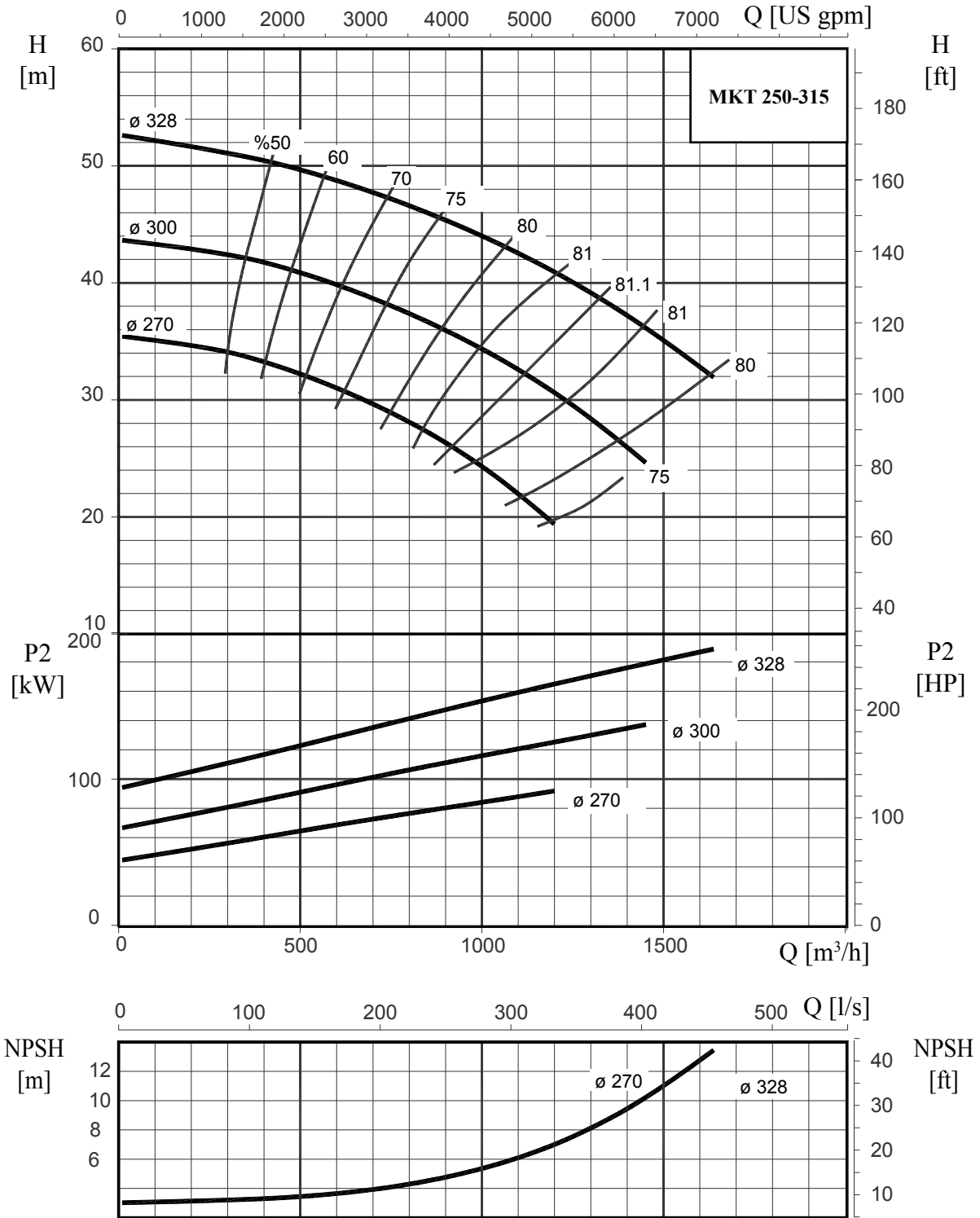

**Αποδόσεις σε/ Performance at 1750 r.p.m. 60 Hz**

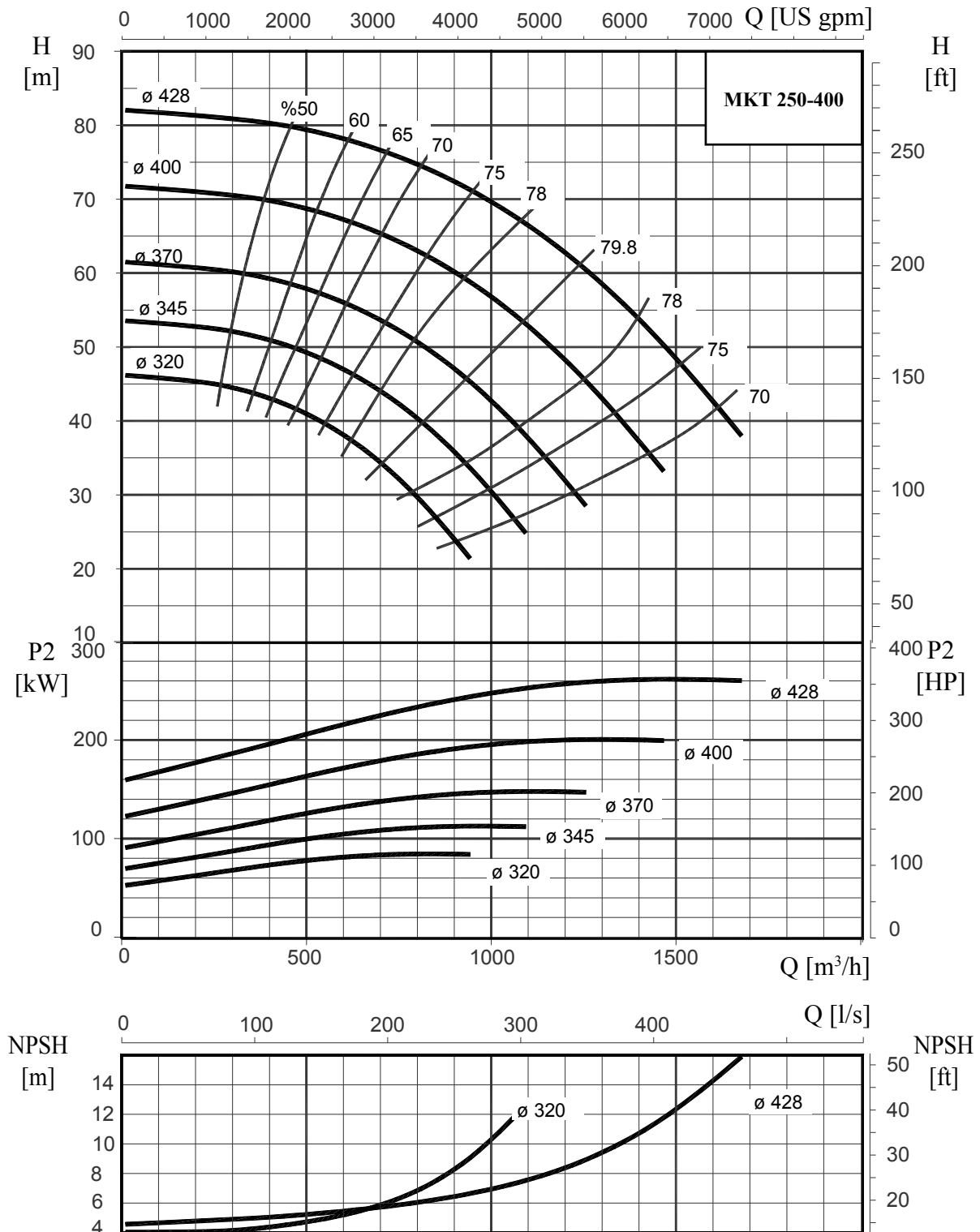

**Αποδόσεις σε/ Performance at 1750 r.p.m. 60 Hz**

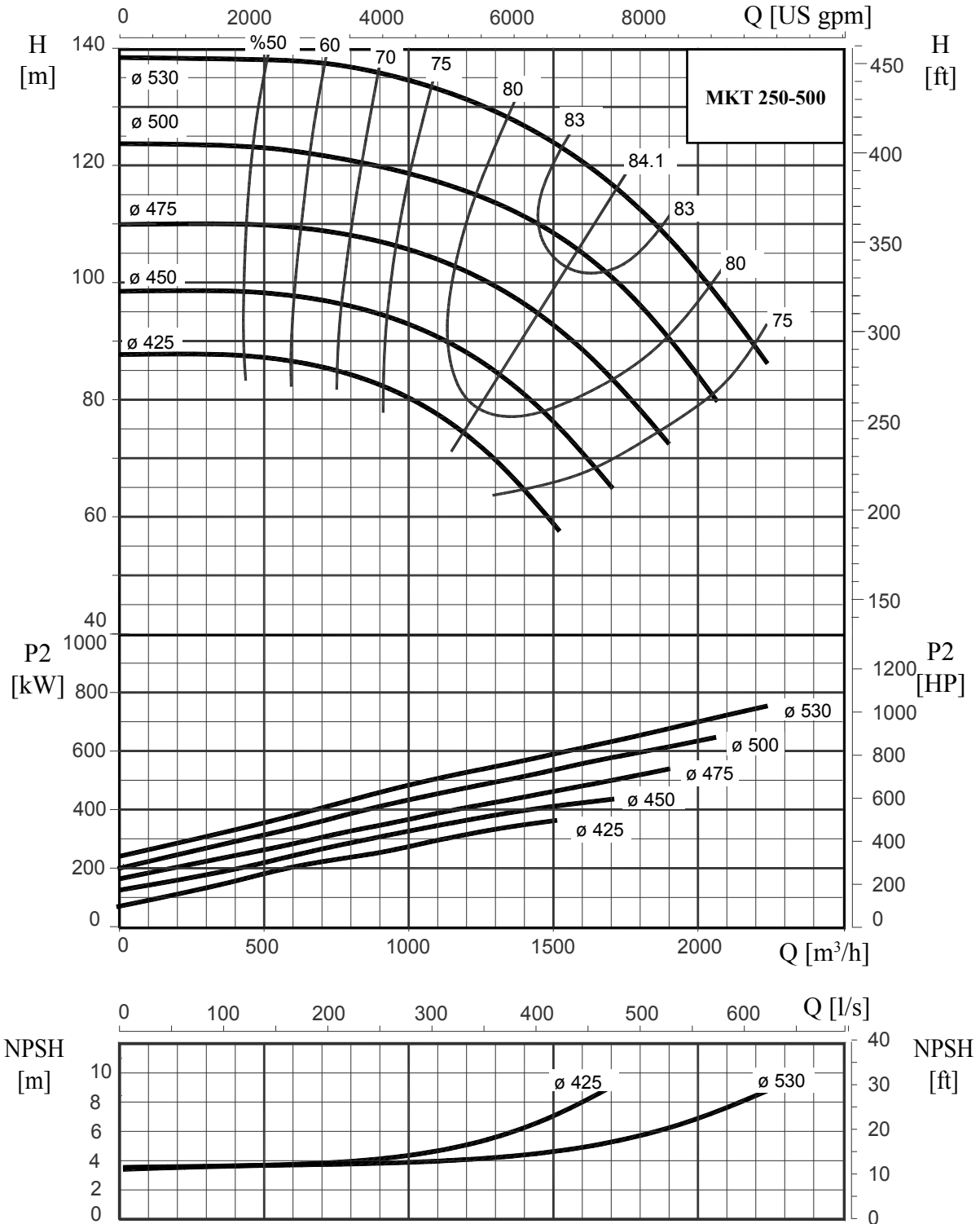

**Αποδόσεις σε/ Performance at 1750 r.p.m. 60 Hz**

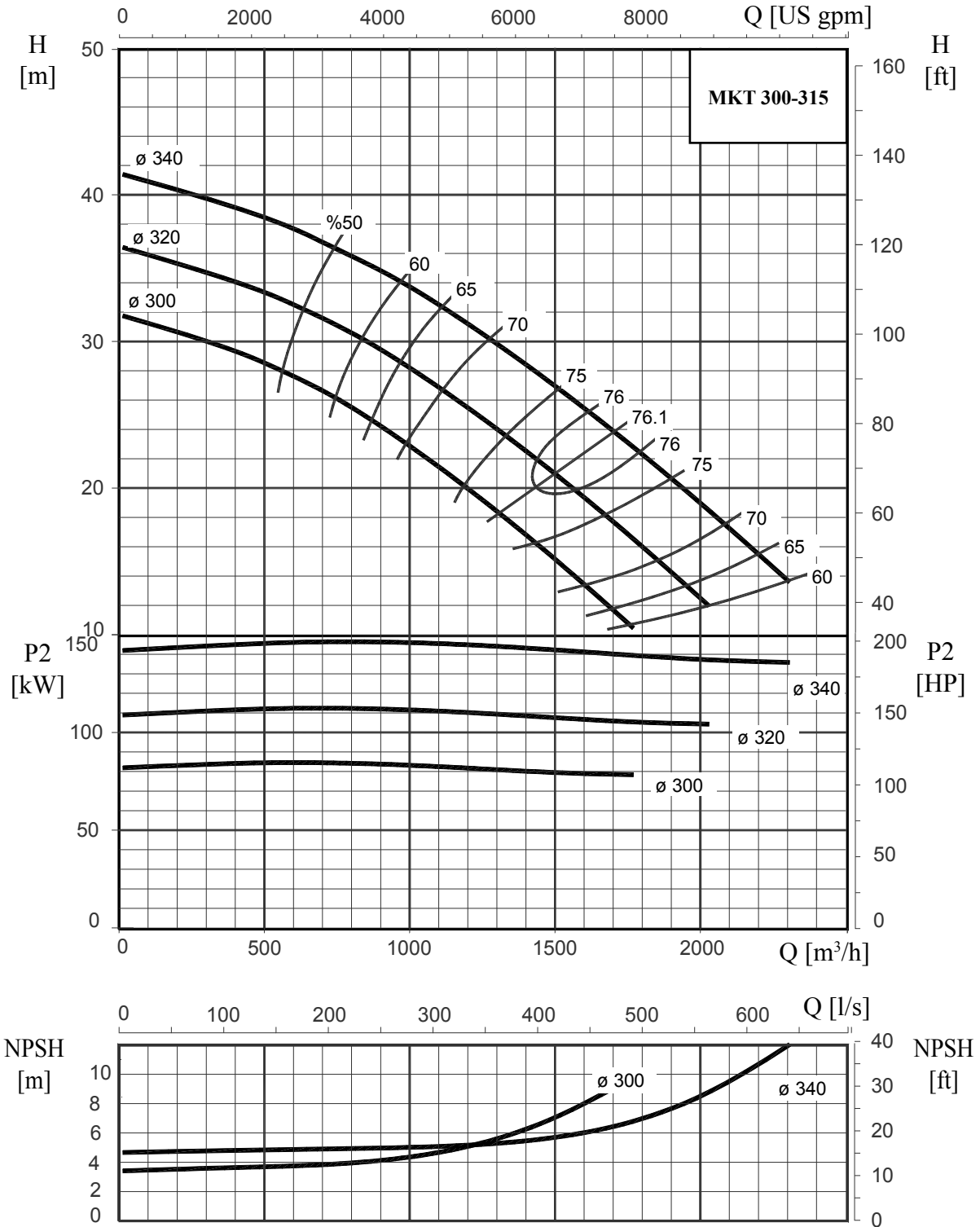

**Αποδόσεις σε/ Performance at 1750 r.p.m. 60 Hz**

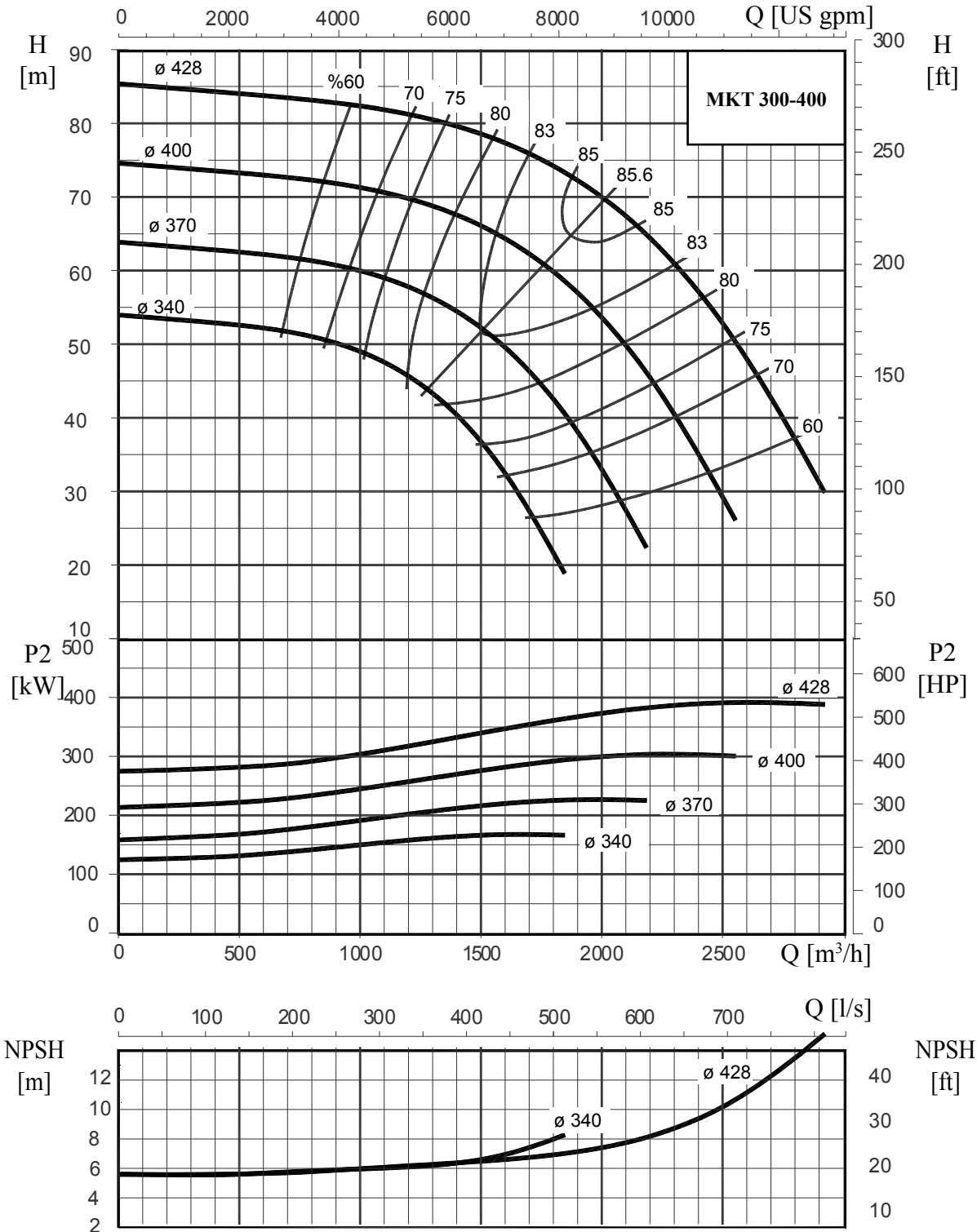

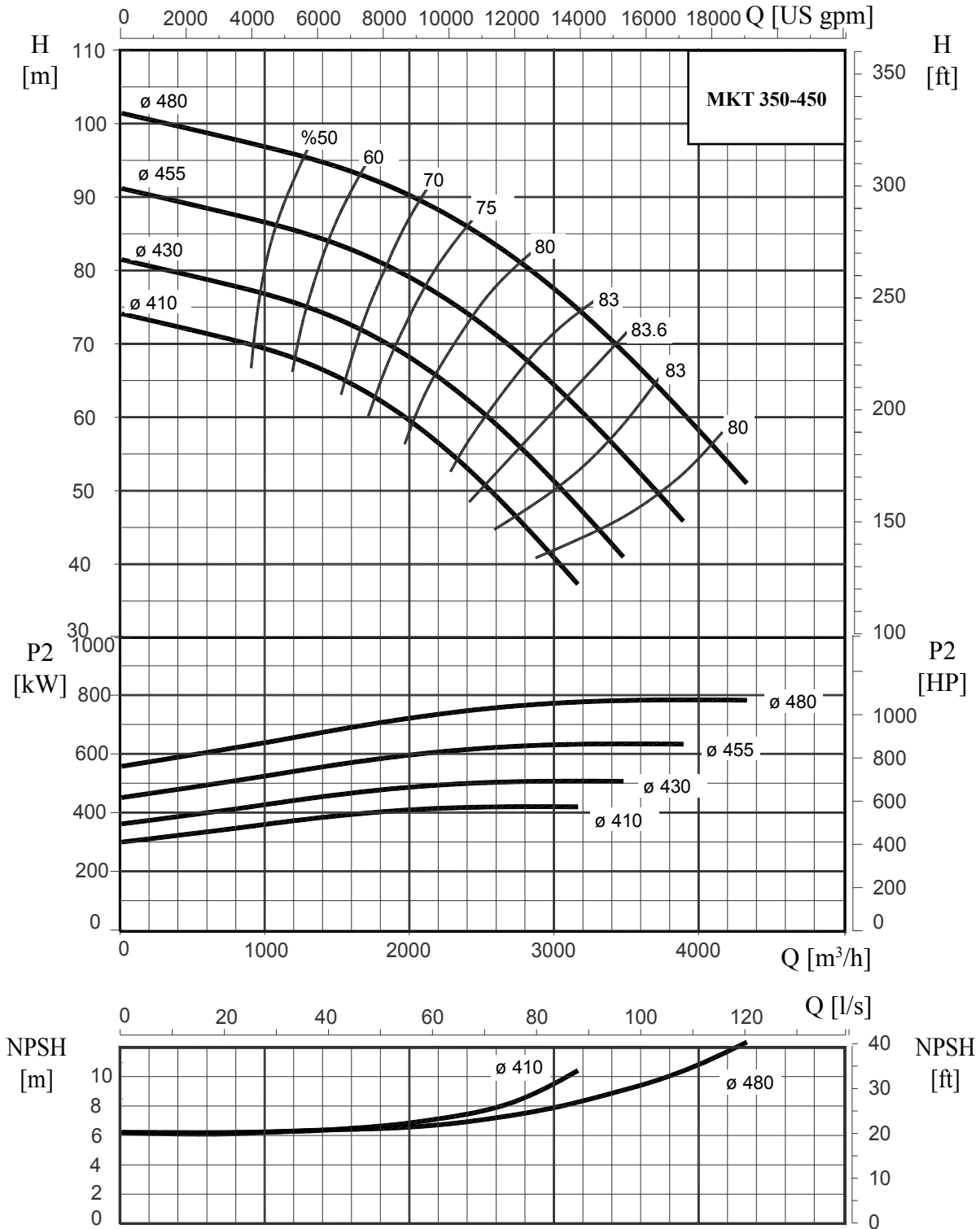

**Αποδόσεις σε/ Performance at 1750 r.p.m. 60 Hz**

Submersible & Axial Pumps Industry  
**FLINOS BROS - K. MARINAKIS S.A.**

7th klm. Argos 212 00 ARGOS - GREECE  
Tel. +30 27510 91498, 91490 - Fax. 91009

E-mail: [info@anavalos.gr](mailto:info@anavalos.gr), web site: [www.anavalos.gr](http://www.anavalos.gr)



Βιομηχανία Αντλιών  
**ΑΦΟΙ ΦΛΙΝΟΥ - Κ. ΜΑΡΙΝΑΚΗΣ Α.Β.Ε.Ε.**

7ο χλμ. Άργους - Κορίνθου 21 200 Άργους  
Τηλ. 27510 91498, 91490 - Fax. 91009